

OLYMPUS[®]

Your Vision, Our Future

System Microscope

BX53M/BXFM

BX3M Series

Advanced Microscopy Simplified

NEW

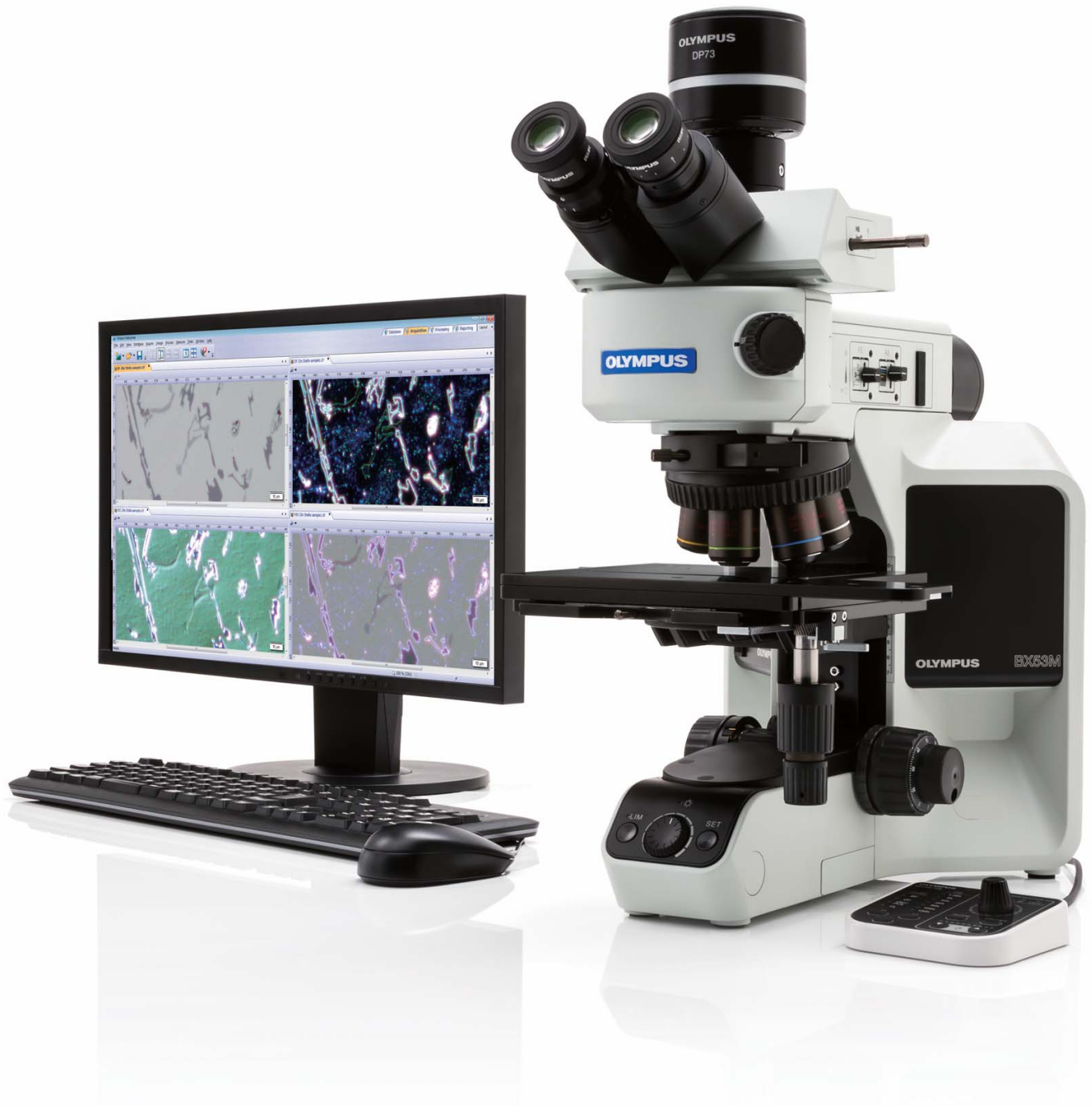

Designed for Industrial and Materials Science Applications

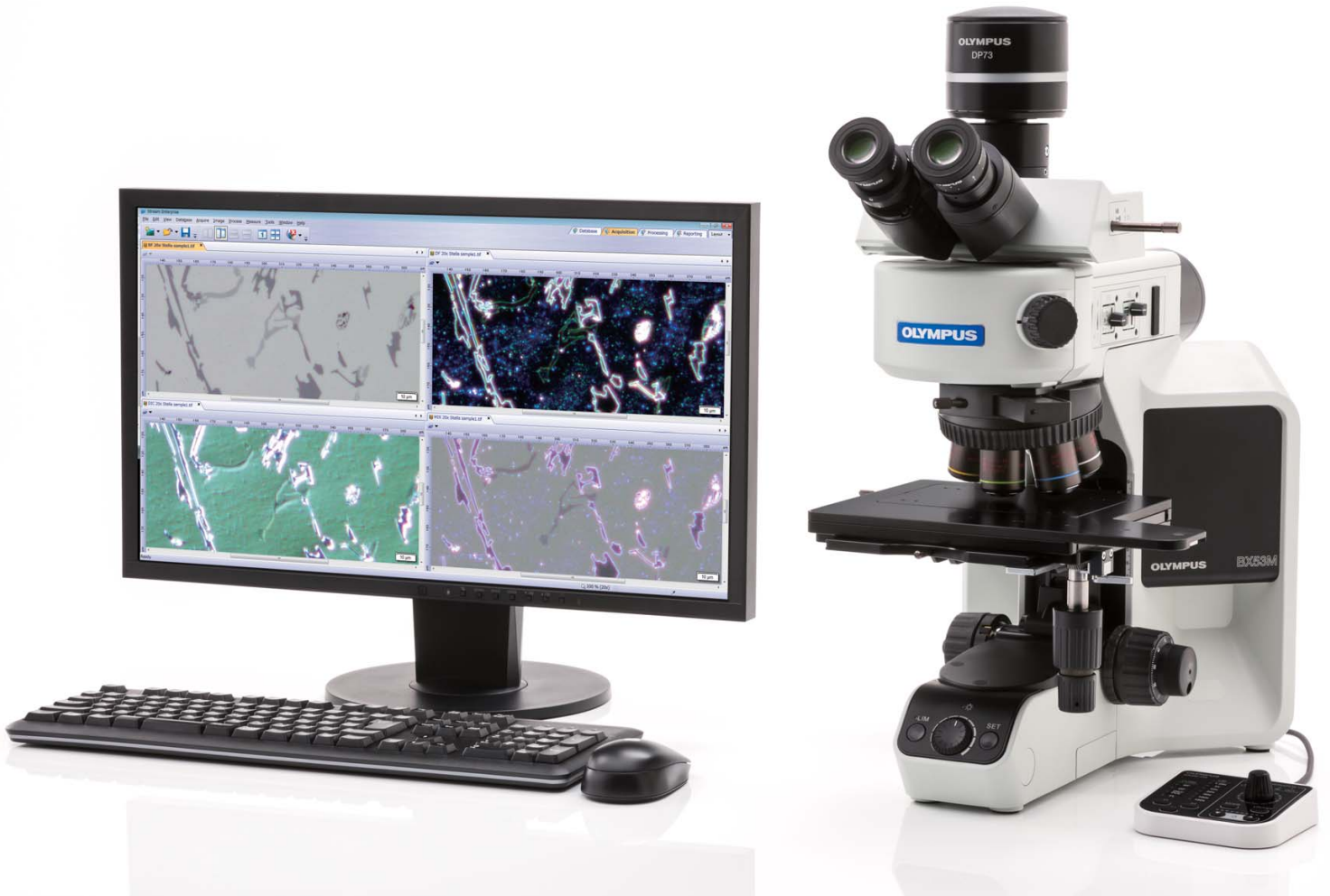

Designed with modularity in mind, the BX3M series provide versatility for a wide variety of materials science and industrial applications. With improved integration with OLYMPUS Stream software, the BX3M provides a seamless workflow for standard microscopy and digital imaging users from observation to report creation.



Functions marked with this icon require OLYMPUS Stream software.

Advanced Microscopy Simplified

User-Friendly

Simplified and guided operation of the microscope settings makes it easier for users to make adjustments and reproduce system settings.

Functional

Designed for traditional industrial microscopy, the BX3M has expanded functionality to meet a broader range of applications and inspection techniques.

Precision Optics

Olympus has a long history of producing quality optics, providing superior images both in the eyepieces and on the monitor.

Fully Customizable

Modular design gives users flexibility to build a system that meets their specific needs.

Intuitive Microscope Controls: Comfortable and Easy to Use

Inspection tasks often take a long time to adjust the microscope settings, acquire the image, and make the necessary measurements to satisfy reporting requirements. Users sometimes invest time and money for professional microscope training, or work with limited knowledge about a microscope's full potential.

The BX3M simplifies complex microscopy tasks through its well-designed and easy-to-use controls. Users can get the most out of the microscope without the need for extensive training. The easy, comfortable operation of the BX3M also improves reproducibility by minimizing human error.

Simple Illuminator: Traditional techniques made easy

The illuminator minimizes complicated actions that are usually necessary during microscope operation. A dial at the front of the illuminator enables the user to easily change the observation method. An operator can quickly switch between the most frequently used observation methods in reflected light microscopy, such as from brightfield, to darkfield, to polarized light, in order to readily change between different types of analyses. In addition, simple polarized light observation is adjustable by rotating the analyzer.

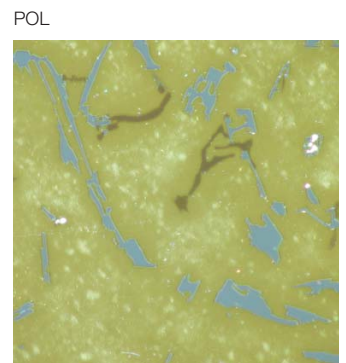
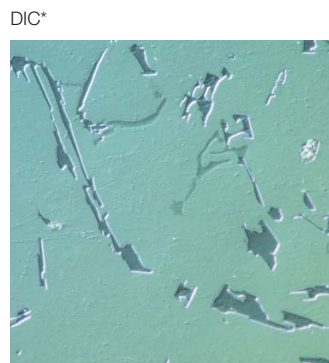
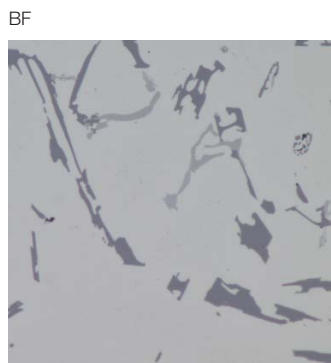

Polished sample of AISi

*Requires DIC slider for use

Intuitive Microscope Controls

Using the proper aperture stop and field stop settings provides good image contrast and makes full use of the numerical aperture of the objective. The legend guides the user to the correct setting based on the observation method and objective in use.

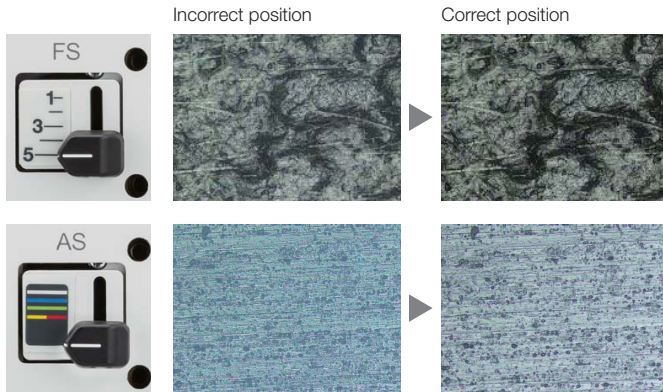

Coded Hardware: Easily restore microscope settings



The BX3M employs new coded functions that integrate the microscope's hardware settings with OLYMPUS Stream image analysis software. The observation method, illumination intensity, and objective position are all recorded within the software and/or the handset. The coded functions enable the microscope settings to be automatically saved with each image, making it easier to reproduce the settings at a later time and provide documentation for reporting purposes. This saves the operator time and minimizes the chance that an incorrect setting will be used. The current observation settings are always clearly displayed both on the hand switch and in the software.

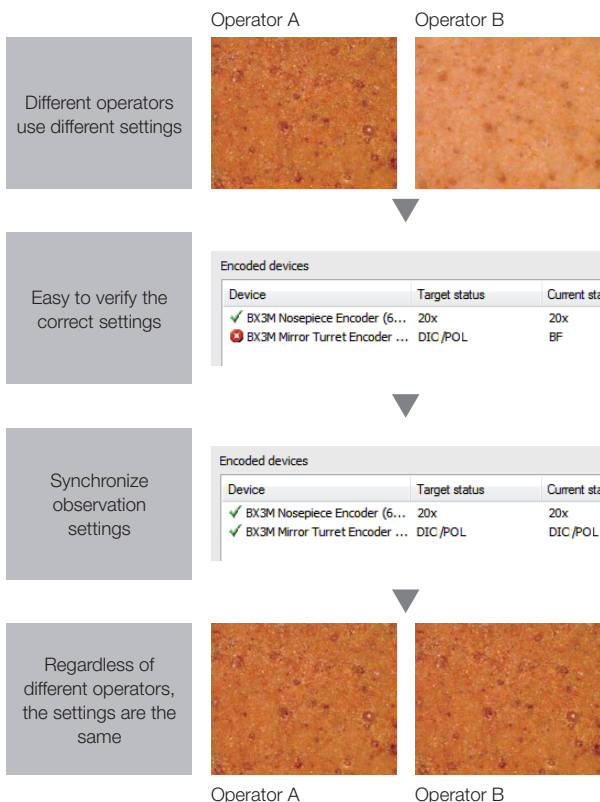

Focus Scale Index: Find the focus quickly

The focus scale index on the frame supports quick access to the focal point. Operators can roughly adjust the focal point without viewing the sample through an eyepiece, saving time when inspecting samples that are different heights.



Light Intensity Manager: Consistent illumination

During the initial setup, the illumination intensity can be adjusted to match the specific hardware configuration of the coded illuminator and/or coded nosepiece.

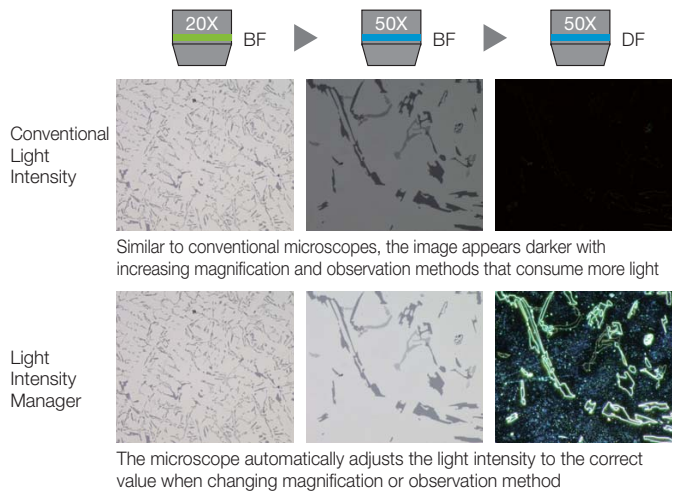

Easy and Ergonomic Operation

Ergonomics are of the utmost importance for all users. Both standalone microscope users and those integrating with OLYMPUS Stream image analysis software benefit from ergonomic handset controls that clearly display the hardware position. The simple handsets enable the user to focus on their sample and the inspection they need to perform.

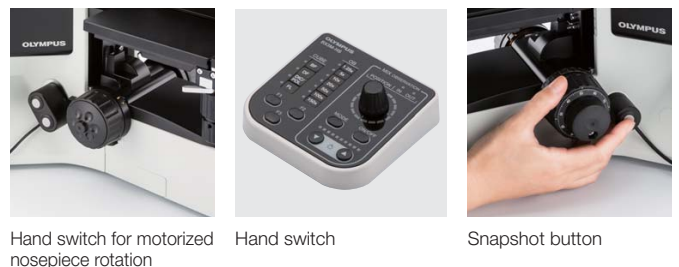

Functionality for a Range of Inspection and Analytical Tasks

The BX3M maintains the traditional contrast methods of conventional microscopy, such as brightfield, darkfield, polarized light, and differential interference contrast. As new materials are developed, many of the difficulties associated with detecting defects using standard contrast methods can be solved using advanced microscopy techniques for more accurate and reliable inspections. New illumination techniques and options for image acquisition within OLYMPUS Stream image analysis software give users more choices of how to evaluate their samples and document findings. In addition, the BX3M also accommodates larger-size, heavier, and more specialized samples than conventional models.

Advanced Imaging

MIX Observation: The invisible becomes visible

The BX3M's MIX observation technology combines brightfield and darkfield illumination methods. The LEDs in the MIX slider shine directional darkfield on the sample, which is similar to traditional darkfield, but with more flexibility. This combination of brightfield and directional darkfield is called MIX illumination, and is especially helpful to highlight defects and differentiate raised surfaces from depressions.

Conventional

Brightfield shines the light straight down on the sample while traditional darkfield highlights scratches and imperfections in a flat surface by illuminating the sample from the side of the objective.

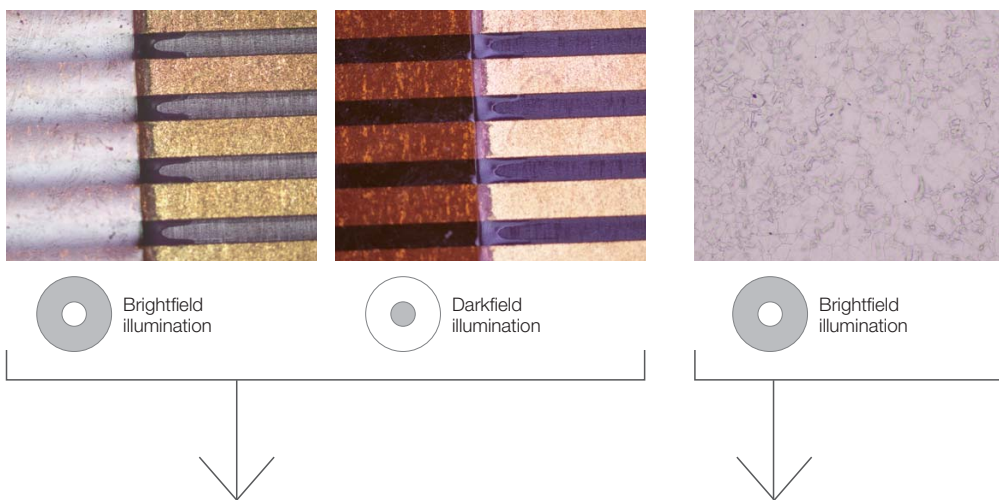

Advanced

MIX is a combination of brightfield and directional darkfield from a ring of LEDs. The LEDs can be adjusted to select which direction to illuminate from.

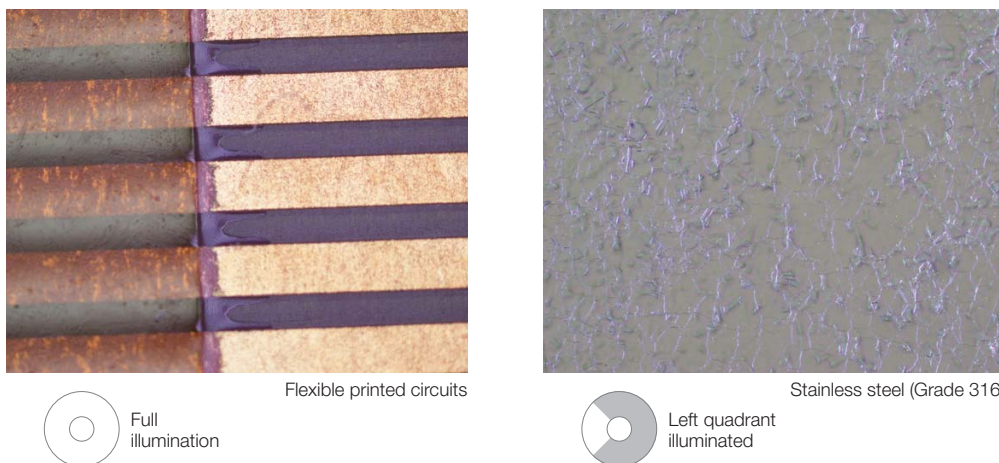

Instant MIA: Easily move the stage for panorama



You can now stitch images easily and quickly just by moving the XY knobs on the manual stage; no motorized stage is necessary. OLYMPUS Stream uses pattern recognition to generate a panoramic image giving users a wider field of view than a single frame.



Instant MIA image of a coin

EFI: Create all-in-focus images



The Extended Focus Imaging (EFI) function within OLYMPUS Stream captures images of samples whose height extends beyond the depth of focus of the objective and stacks them together to create one image that is all in focus. EFI can be executed with either a manual or motorized Z-axis and creates a height map for easy structure visualization. It is also possible to construct an EFI image while offline within Stream Desktop.

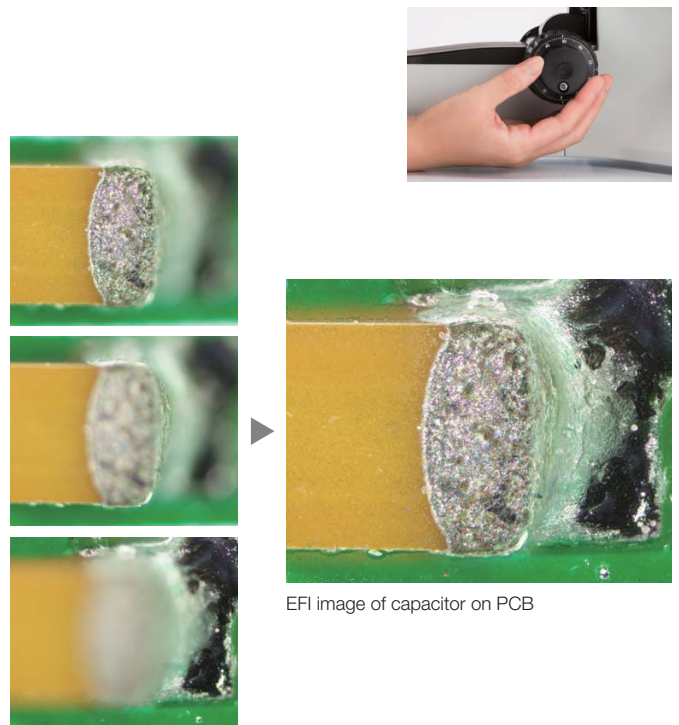

EFI image of capacitor on PCB

HDR: Capture both bright and dark areas



Using advanced image processing, high dynamic range (HDR) adjusts for differences in brightness within an image to reduce glare. HDR improves the visual quality of digital images thereby helping to generate professional-looking reports.

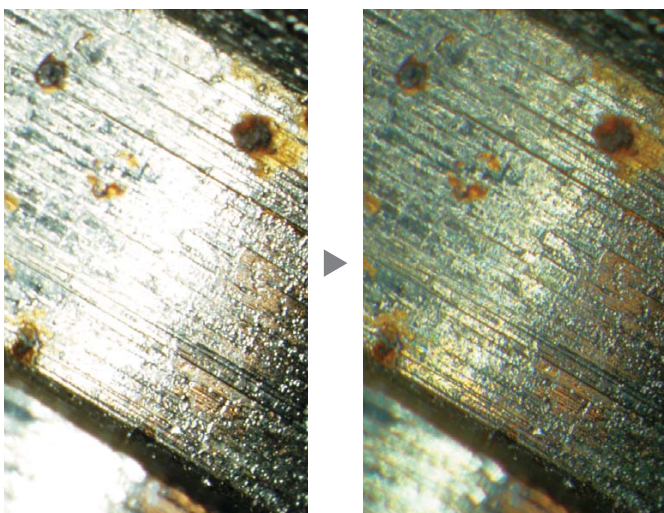

Clearly exposed for both dark and bright regions by HDR
(Sample: Fuel injector bulb)



Contrast enhancement by HDR
(Sample: Sliced magnesite)

Advanced Measurement

Routine or Basic Measurement

Various measurement functions are available through OLYMPUS Stream so that the user can easily obtain useful data from the images. For quality control and inspection, measuring features on images are often required. All levels of OLYMPUS Stream licenses include interactive measurement functions such as distances, angles, rectangles, circles, ellipses, and polygons. All measured results are saved with the image files for further documentation.

Count and Measure

Object detection and size distribution measurement are among the most important applications in digital imaging. OLYMPUS Stream incorporates a detection engine that utilizes threshold methods to reliably separate objects (e.g., particles, scratches) from the background.

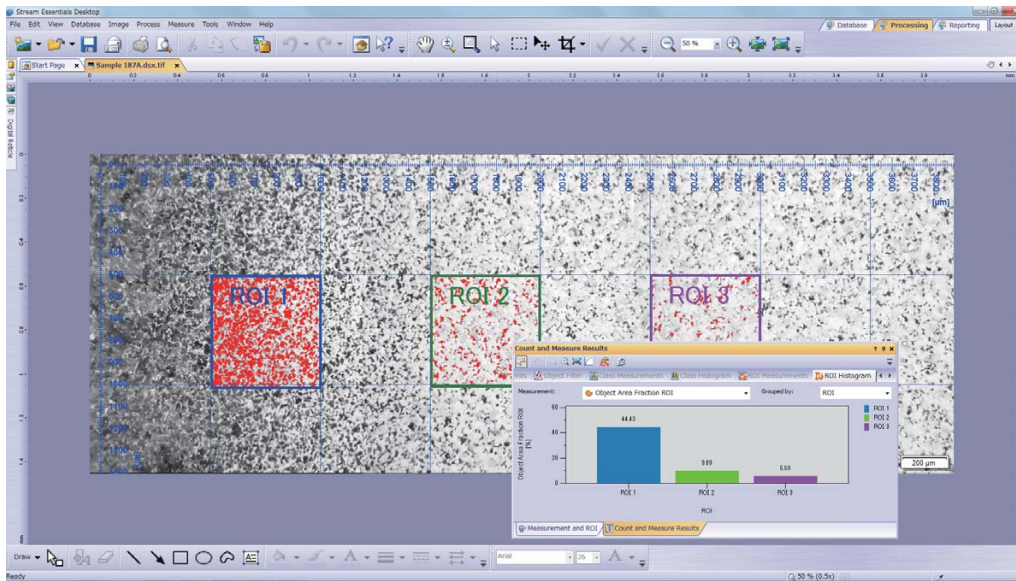

Count and Measure

Materials Science Solutions

OLYMPUS Stream offers an intuitive, workflow-oriented interface for complex image analysis. At the click of a button, the most complex image analysis tasks can be executed quickly, precisely, and in compliance with most common industrial standards. With a significant reduction in processing time for repeated tasks, materials scientists can concentrate on analysis and research. Modular add-ins for inclusions and intercept charts are easily performed at any time.

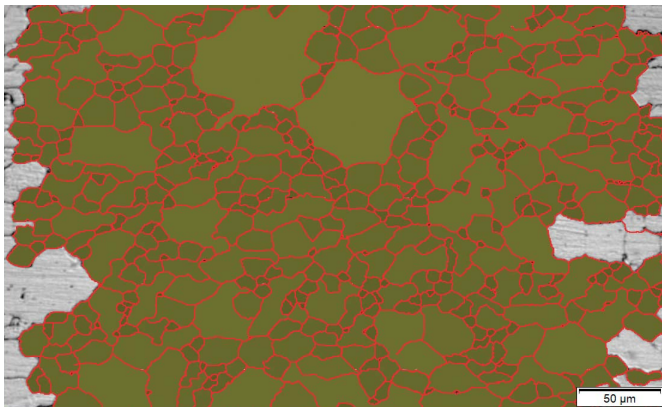

Example: Object detection and report for Grains Planimetric

3D Sample Measurement

When using an external motorized focus drive, an EFI image can be quickly captured and displayed in 3D. The height data acquired can be used for 3D measurements on the profile or from the single view image.

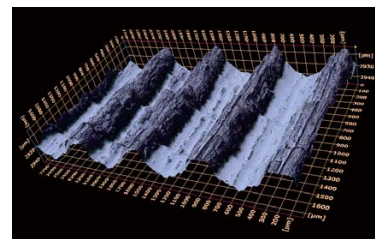

3D surface view (roughness test sample)

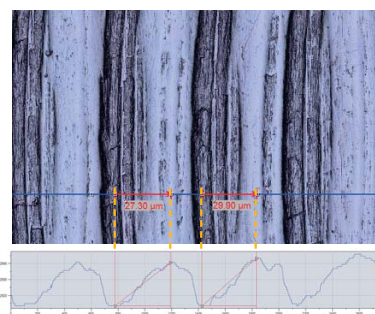

Single view and 3D profile measurement

Advanced Sample Capacity

View More Sample Types and Sizes

The new 150 × 100 mm stage provides a longer travel in the X direction than previous models. This, together with the flat-top design, enables large samples or multiple samples to be easily placed on the stage. The stage plate has tapped holes to attach a sample holder. The larger stage provides flexibility to users by enabling them to inspect more samples on one microscope, saving valuable lab space. The stage's adjustable torque facilitates fine positioning under high magnification with a narrow field of view.

Flexibility for Sample Height and Weight

Samples up to 105 mm can be mounted on the stage with the optional modular unit. Due to the improved focusing mechanism, the microscope can accommodate a total weight (sample + stage) of up to 6 kg. This means that larger and heavier samples can be inspected on the BX3M, so fewer microscopes are required in the lab. By strategically positioning a rotatable holder for 6-inch wafers off-center, users can observe the whole wafer surface by just rotating the holder when moving through the 100 mm travel range. The stage's torque adjustment is optimized for ease of use and the comfortable handle grip makes it easy to find the region of interest of the sample.

Flexibility for Sample Size

When samples are too large to place on a traditional microscope stage, the core optical components for reflected light microscopy can be arranged in a modular configuration. This modular system, the BXFM, can be mounted on a larger stand via a pole or mounted to another instrument of choice using a mounting bracket. This enables users to take advantage of Olympus' renowned optics even when their samples are unique in size or shape.



BX53MRF-S



BXFM

ESD Compatible: Protect electronic devices from electrostatic discharge

The BX3M has an ESD dissipation capability that protects electronic devices from static electricity caused by human or environmental factors.

A History of Leading-edge Optics

Olympus' history of developing high-quality optics has resulted in a record of proven optical quality and microscopes that offer excellent measurement accuracy.

Wave Front Aberration Control

When using a microscope for advanced research or system integration, optical performance must be standardized for all objectives. Olympus' UIS2 objectives go beyond conventional numerical aperture (NA) and working distance (WD) performance standards by providing wave front aberration control, that minimizes the aberrations that lower resolution.

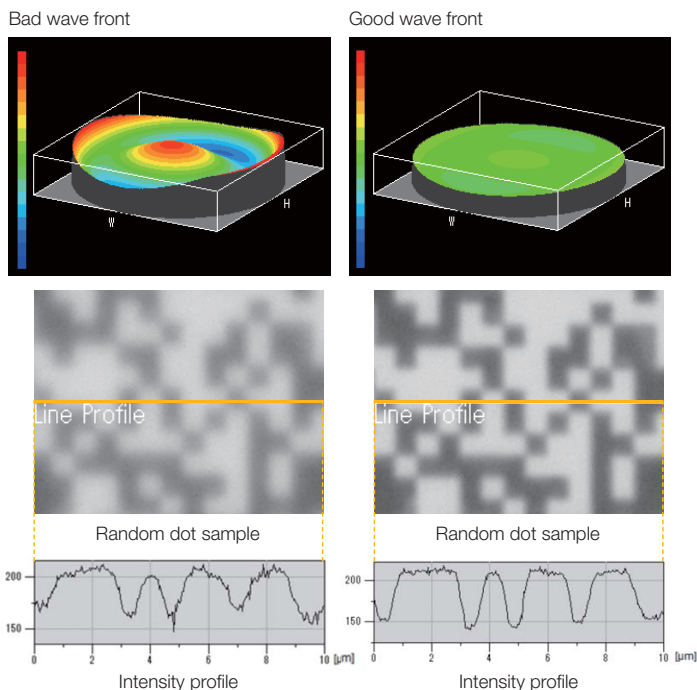

Auto Calibration

Similar to digital microscopes, automatic calibration is available when using OLYMPUS Stream. Auto calibration eliminates human variability in the calibration process, leading to more reliable measurements. Auto calibration uses an algorithm that automatically calculates the correct calibration from an average of multiple measurement points. This minimizes variance introduced by different operators and maintains consistent accuracy, improving reliability for regular verification.

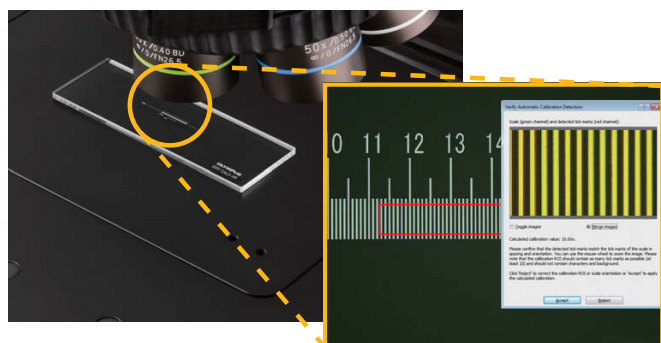

LED Illumination

The BX3M utilizes a high-intensity white LED light source for both reflected and transmitted light. The LED maintains a consistent color temperature regardless of intensity. LEDs provide efficient, long-life illumination that is ideal for inspecting materials science applications.

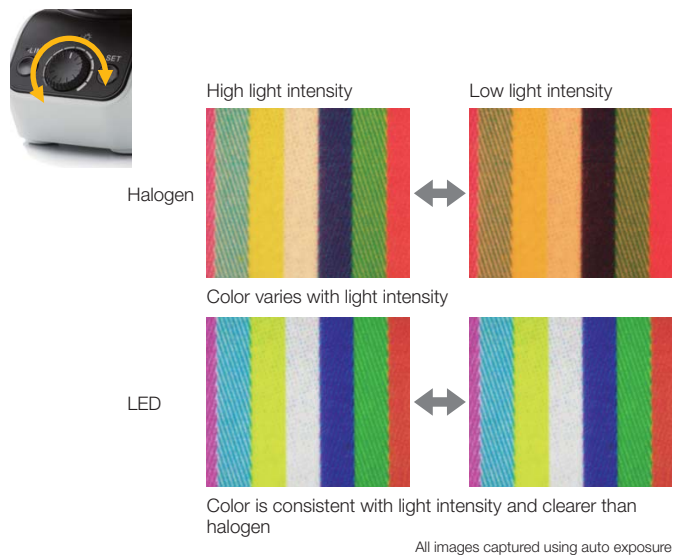

Shading Correction

Shading correction is implemented within OLYMPUS Stream software to accommodate for shading around the corners of an image. When used with intensity threshold settings, shading correction provides more precise analysis. Additionally, a more uniform panoramic image is acquired when tiling images with MIA.

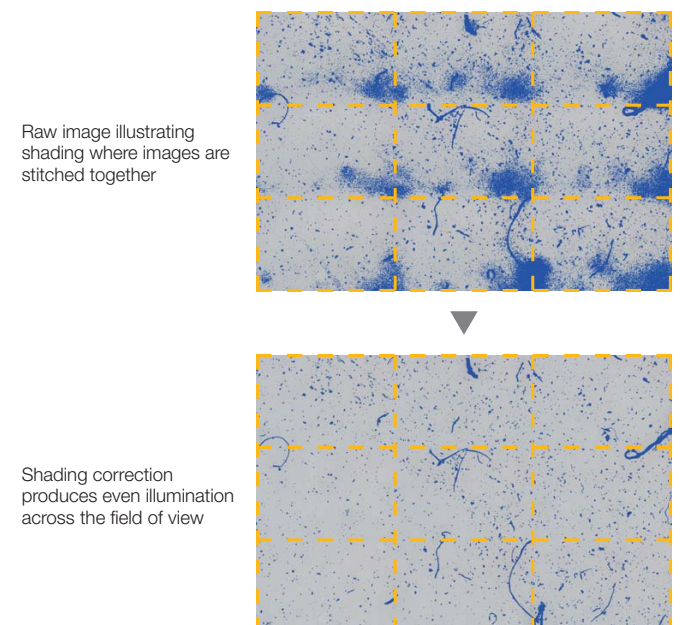

Applications

Reflected light microscopy spans a range of applications and industries. These are just a selection of examples of what can be achieved using different observation methods.

Darkfield

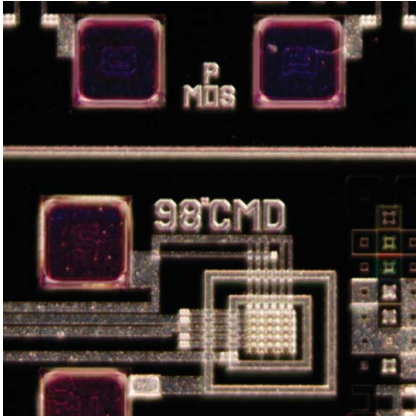

Surface mounting board: DF

Darkfield enables the observation of scattered or diffracted light from the specimen. Anything that is not flat reflects this light while anything that is flat appears dark so imperfections clearly stand out. The user can identify the existence of even a minute scratch or flaw down to the 8 nm level—smaller than the resolving power limit of an optical microscope. Darkfield is ideal for detecting minute scratches or flaws on a specimen and examining mirror surface specimens, including wafers.

Differential Interference Contrast

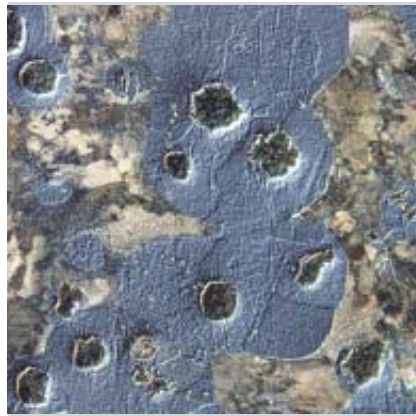

Nodular cast iron etched: DIC

DIC is a microscopic observation technique in which the height difference of a specimen not detectable with brightfield becomes a relief-like or three-dimensional image with improved contrast. This technique utilizes polarized light and can be customized with a choice of three specially designed prisms. It is ideal for examining specimens with very minute height differences, including metallurgical structures, minerals, magnetic heads, hard-disk media, and polished wafer surfaces.

Polarized Light

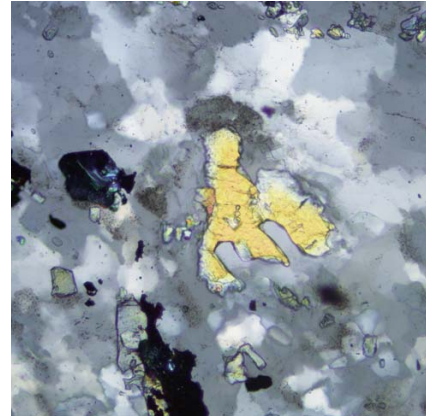

Sericite: POL

This microscopic observation technique utilizes polarized light generated by a set of filters (analyzer and polarizer). The characteristics of the sample directly affect the intensity of the light reflected through the system. It is suitable for metallurgical structures (i.e., growth pattern of graphite on nodular casting iron), minerals, LCDs and, semiconductor materials.

Fluorescence

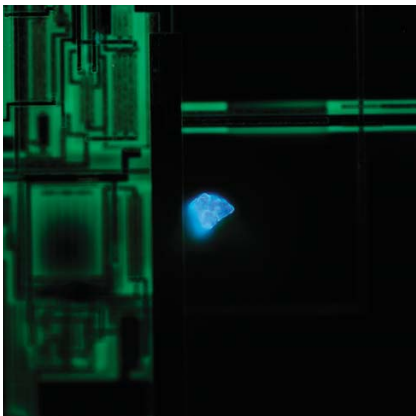

Particle on semiconductor wafer: FL

This technique is used for specimens that fluoresce (emit light of a different wavelength) when illuminated with a specially designed filter cube that can be selected to the specific application. It is suitable for inspection of contamination on semiconductor wafers, photo-resist residues, and detection of cracks through the use of fluorescent dye. An optional apochromatic lamp housing collector lens system can be added to compensate for chromatic aberrations from visible light to near-infrared light.

Infra-Red

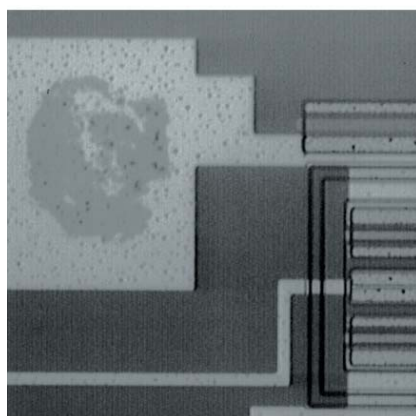

Electrode section: IR

IR observation is the preferred method of nondestructively inspecting the inside of electronic devices constructed with silicon or glass that easily transmit IR wavelengths of light.

Transmitted Light Observation

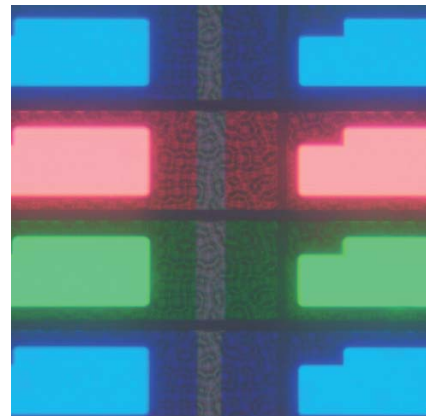

LCD color filter: TL BF + HDR

For transparent samples such as LCDs, plastics, and glass materials, true transmitted light observation is available by using a variety of condensers. Examining samples in transmitted brightfield and polarized light can be accomplished all in one convenient system.

Fully Customizable

Modular design enables various configurations to meet users' requirements.

Example Configurations for Materials Science

BX53M Reflected and Reflected/Transmitted Light Combination

There are two types of microscope frames in the BX3M series, one for reflected light only and one for both reflected and transmitted light. Both frames can be configured with manual, coded, or motorized components. The frames are outfitted with ESD capability to protect electronic samples.



BX53MRF-S example configuration



BX53MTRF-S example configuration

BX53M IR Combination

IR objectives can be used for semiconductor inspection, measurement, and processing applications where imaging through silicon is required to see the pattern. 5X to 100X infrared (IR) objectives are available with chromatic aberration correction from visible light wavelengths through the near infrared. For high-magnification work, rotating the correction collar of the LCPLN-IR series of lenses corrects for aberrations caused by sample thickness. A clear image is obtained with a single objective.

Objectives	Magnifications	NA	W.D. (mm)	Cover Glass Thickness (mm)	Silicon Thickness (mm)	Resolution*1 (μm)
LMPLN-IR	5X	0.1	23	0-0.17	—	6.71*3
	10X	0.3	18	0-0.17	—	2.24*3
LCPLN-IR*2	20X	0.45	8.3	0-1.2	0-1.2	1.49*3
	50X	0.65	4.5	0-1.2	0-1.2	1.03*3
	100X	0.85	1.2	0-0.7	0-1.0	0.79*3

*1 Resolutions calculated with aperture iris diaphragm wide open

*2 Limited up to FN 22, not compatible with FN 26.5

*3 With the use of 1100 nm



IR objectives

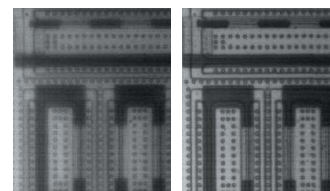

Without correction Correction

BX53M Polarized Light Combination

The optics of the BX53M polarized light combination provide geologists with the right tools for high-contrast polarized light imaging. Applications such as mineral identification, investigating the optical characteristics of crystals, and observing solid rock sections benefit from system stability and precise optical alignment.

Bertrand Lens for Conoscopic and Orthoscopic Observations

With a U-CPA conoscopic observation attachment, switching between orthoscopic and conoscopic observation is simple and fast. It is focusable for clear back focal plane interference patterns. The Bertrand field stop makes it possible to obtain consistently sharp and clear conoscopic images.



Polarized light accessories

Strain-free Optics

Thanks to Olympus' sophisticated design and manufacturing technology, the UPLFLN-P strain-free objectives reduce internal strain to the minimum. This means a higher EF value, resulting in excellent image contrast.



UPLFLN-P strain-free objectives

UPLFLN-P series

Objectives	NA	W.D.
UPLFLN 4XP	0.13	17.0 mm
UPLFLN 10XP	0.3	10.0 mm
UPLFLN 20XP	0.5	2.1 mm
UPLFLN 40XP	0.75	0.51 mm
UPLFLN 100XOP	1.3	0.2 mm

PLN-P

Objectives	NA	W.D.
PLN 4XP	0.1	18.5 mm

ACHN-P series

Objectives	NA	W.D.
ACHN 10XP	0.25	6.0 mm
ACHN 20XP	0.40	3.0 mm
ACHN 40XP	0.65	0.45 mm
ACHN 100XOP	1.25	0.13 mm

*All UIS2 objectives and WHN eyepieces: lead-free eco-glass

BXFM System

The BXFM can be adapted to special applications or integrated into other instruments. The modular construction provides for straightforward adaptation to unique environments and configurations with a variety of special small illuminators and fixturing mounts.



BX53M orthoscopic configuration

BX53M conoscopic/
orthoscopic configuration

An Extensive Range of Compensator and Wave Plates

Six different compensators are available for measurements of birefringence in rock and mineral thin sections. Measurement retardation level ranges from 0 to 20λ . For easier measurement and high image contrast, the Berek and Senarmont compensators can be used, which change the retardation level in the entire field of view.



Measuring range of compensators

Compensator	Measurement Range	Applications
Thick Berek (U-CTB)	0-11000 nm (20λ)	Measurement of high retardation level ($R^* > 3\lambda$), (crystals, macromolecules, fiber, etc.)
Berek (U-CBE)	0-1640 nm (3λ)	Measurement of retardation level (crystals, macromolecules, living organisms, etc.)
Senarmont Compensator (U-CSE)	0-546 nm (1λ)	Measurement of retardation level (crystals, living organisms, etc.) Enhancement of Image Contrast (living organisms, etc.)
Brace-Koehler Compensator 1/10 λ (U-CBR1)	0-55 nm (1/10 λ)	Measurement of low retardation level (living organisms, etc.)
Brace-Koehler Compensator 1/30 λ (U-CBE2)	0-20 nm (1/30 λ)	Measurement of image contrast (living organisms, etc.)
Quartz Wedge (U-CWE2)	500-2200 nm (4λ)	Approximate measurement of retardation level (crystal, macromolecules, etc.)

*R = retardation level
For more accurate measurement, it is recommended that compensators (except U-CWE2) be used together with the interference filter 45-IF546



Modular Design, Build Your System Your Way

Microscope Frames

There are two microscope frames for reflected light; one also has transmitted light capability. An adapter is available to raise the illuminator to accommodate taller samples.

	■: Possible	Reflected light	Transmitted light	Sample height
1	BX53MRF-S	■		0-65 mm
2	BX53MTRF-S	■	■	0-35 mm
1, 3	BX53MRF-S + BX3M-ARMAD	■		40-105 mm
2, 3	BX53MTRF-S + BX3M-ARMAD	■	■	40-75 mm



Stands

For microscopy applications where the sample will not fit on a stage, the illuminator and optics can be mounted on a larger stand or to another piece of equipment.

BXFM + BX53M illuminator configuration

1	BXFM-F	Frame interface is wall mounting/32 mm pillar
2	BX3M-ILH	Illuminator holder
3	BXFM-ILHSPU	Counter spring for BXFM
5	U-ST	Stand
6	SZ-STL	Large stand

BXFM + U-KMAS illuminator configuration

1	BXFM-F	Frame interface is wall mounting/32 mm pillar
4	BXFM-ILHS	U-KMAS holder
5	U-ST	Stand
6	SZ-STL	Large stand



Tubes

For microscope imaging with eyepieces or for camera observation, select tubes by imaging type and operator's posture during observation.

	FN	Type	Angle type	Image	Number of diopter adjustment mechanisms
1	U-BI30-2	Binocular	Fixing	Reverse	1
2	U-TBI-3	Binocular	Tilting	Reverse	1
3	U-TR30-2	Trinocular	Fixing	Reverse	1
4	U-TR30IR	Trinocular for IR	Fixing	Reverse	2
5	U-ETR-4	Trinocular	Fixing	Erect	2
6	U-TTR-2	Trinocular	Tilting	Reverse	2
7	U-SWTR-3	Trinocular	Fixing	Reverse	2
8	U-SWETTR-5	Trinocular	Tilting	Erect	2
9	U-TLU	Single port	—	—	—
10	U-TLUIR	Single port for IR	—	—	—



Illuminators

The illuminator projects light onto the sample based on the observation method selected. Software interfaces with coded illuminators to read the cube position and automatically recognize the observation method.



■: Possible		Coded function	Light source	BF	DF	DIC	POL	IR	FL	MIX	AS/FS	
1	BX3M-RLAS-S	Fixed 3 cube position	LED - built in	■	■	■	■			■	■	
2	BX3M-URAS-S	Attachable 4 cube position	LED	■	■	■	■			■	■	
			Halogen	■	■	■	■	■		■	■	
			Mercury/Light guide	■	■	■	■		■	■	■	
3	BX3M-RLA-S		LED	■	■	■	■			■	■	
			Halogen	■	■	■	■	■		■	■	
4	BX3M-KMA-S		LED - built in	■		■	■			■		
5	BX3-ARM	Mechanical arm for transmitted light										
6	U-KMAS		LED		■		■				■	
			Halogen		■		■		■			■

Light Sources

Light sources and power supplies for sample illumination, choose the appropriate light source for the observation method.

Standard LED light source configuration

1	BX3M-LEDR	LED lamp housing for reflected light
2	U-RCV	DF converter for BX3M-URAS-S, required for observation with DF and BF when necessary
3	BX3M-PSLED	Power supply for LED lamp housing, requires BXTM system
4	BX3M-LEDT	LED lamp housing for transmitted light

Fluorescence light source configuration

5	U-LLGAD	Light guide adapter
2	U-RCV	DF converter for BX3M-URAS-S, required for observation with DF and BF when necessary
6, 7	U-LLG150 (300)	Light guide, length:1.5 m (3 m)
8	U-HGLGPS	Light source for fluorescence
9, 10	U-LH100HG(HGAPO)	Mercury lamp housing for fluorescence
2	U-RCV	DF converter for BX3M-URAS-S, required for observation with DF and BF when necessary
11	U-RFL-T	Power supply for 100W mercury lamp

Halogen and halogen IR light source configuration

12	U-LH100L-3	Halogen lamp housing
13	U-LH100IR	Halogen lamp housing for IR
14	U-RMT	Extender cable for halogen lamp housing, cable length 1.7 m (requires cable extension when necessary)
15, 16	TH4-100 (200)	100V (200V) specification power supply for 100W/50W halogen lamp
17	TH4-HS	Hand switch for light intensity of halogen (dimmer TH4-100 (200) without hand switch)



Nosepieces

Attachment for objectives and sliders. Select by the number of objectives needed and types; also with/without slider attachment.

	■: Possible	Type	Holes	BF	DF	DIC	MIX	ESD	Number of centering holes
1		U-P4RE	Manual	4	■				4
2		U-5RE-2	Manual	5	■				
3		U-5RES-ESD	Coded	5	■			■	
4		U-D6RE	Manual	6	■		■		
5		U-D6RE-ESD-2	Manual	6	■		■	■	
6		U-P6RE	Manual	6	■		■		2
7		U-D7RE	Manual	7	■		■		
8		U-D6RES	Coded	6	■		■		
9		U-D7RES	Coded	7	■		■		
10		U-D5BDREMC	Motorized	5	■	■	■	■	
11		U-5BDRE	Manual	5	■	■			
12		U-D5BDRE	Manual	5	■	■	■	■	
13		U-P5BDRE	Manual	5	■	■	■	■	2
14		U-D6BDRE	Manual	6	■	■	■	■	
15		U-D5BDRES-ESD	Coded	5	■	■	■	■	
16		U-D6BDRES-S	Coded	6	■	■	■	■	
17		U-D6REMC	Motorized	6	■	■	■	■	
18		U-D6BDREMC	Motorized	6	■	■	■	■	



Sliders

Select the slider to complement traditional brightfield observation. The DIC slider provides topographic information about the sample with options to maximize contrast or resolution. The MIX slider provides illumination flexibility with a segmented LED source in the darkfield path.

	Type	Amount of shear	Available objectives	
1	U-DICR	Standard	Medium	MPLFLN, MPLAPON, LMPLFLN, and LCPLFLN-LCD
2	U-DICRH	Resolution	Small	MPLFLN, MPLAPON
3	U-DICRHC	Contrast	Large	LMPLFLN and LCPLFLN-LCD

MIX slider for MIX observation.

	Type	Available objectives	
4	U-MIXR	MIX slider	MPLFLN-BD, LMPLFLN-BD, MPLN-BD



Control Boxes and Hand Switches

Control boxes for interfacing microscope hardware with a PC and hand switches for hardware display and control.

BX3M-CB (CBFM) configuration

1	BX3M-CB	Control box for BX53M system
2	BX3M-CBFM	Control box for BXFM system
3	BX3M-HS	MIX observation control, indicator of coded hardware, programmable function button of software (Stream)
4	BX3M-HSRE	Motorized nosepiece rotation
5	U-HSEXP	Shutter operation of camera

U-CBS configuration

6	U-CBS	Control box for coded functions in BXFM configuration
5	U-HSEXP	Shutter operation of camera

Cable

-	U-MIXRCBL (ECBL)	U-MIXR cable, cable length: 0.5 m (2.9 m)
-	BX3M-RMCBL (ECBL)	Motorized nosepiece cable, cable length: 0.2 m (2.9 m)



Stages

Stages and stage plates for sample placement. Select based on sample shape and size.

150 mm × 100 mm stage configuration

1	U-SIC64	150 mm × 100 mm flat top handle stage
2	U-SHG (T)	Silicone rubber operability handle rubber for improvement (thick type)
3	U-SP64	Stage plate for U-SIC64
4	U-WHP64	Wafer plate for U-SIC64
5	BH2-WHR43	Wafer holder for 4-3 in.
6	BH2-WHR54	Wafer holder for 5-4 in.
7	BH2-WHR65	Wafer holder for 6-5 in.
8	U-SPG64	Glass plate for U-SIC64

100 mm × 100 mm stage configuration

9, 10	U-SIC4R (L) 2	100 mm × 105 mm right (left) handle stage
11	U-MSSP4	Stage plate for U-SIC4R (L) 2
12	U-WHP2	Wafer plate for U-SIC4R (L) 2
6	BH2-WHR43	Wafer holder for 4-3 in.
13	U-MSSPG	Glass plate for U-SIC4R

76 mm × 52 mm stage configuration

14, 15	U-SVR (L) M	76 mm × 52 mm right (left) handle stage
2	U-SHG (T)	Silicone rubber operability handle rubber for improvement (thick type)
16	U-MSSP	Stage plate for U-SVR (L) M
17, 18	U-HR (L) D-4	Thin slide holder for the right (left) opening
19, 20	U-HR (L) DT-4	Thick slide holder for the right (left) opening, for pressing the slide glass to stage top surface, when the specimen is difficult to lift

Other

21	U-SRG	Rotatable stage
22	U-SRP	Rotatable stage for POL, from any position can be 45° click stop
23	U-FMP	Mechanical stage for U-SRP/U-SRG
24	U-SP	Fixed stage of a single plate



Camera Adapters

Adapters for camera observation. Selectable from required field of view and magnification. Actual observation range can be calculated using this formula: actual field of view (diagonal mm) = viewing field (viewing number) ÷ objective magnification.

	Magnification	Centering adjustment (mm)	CCD image area (field number) (mm)			
			2/3 in.	1/1.8 in.	1/2 in.	
1	U-TV1X-2 with U-CMAD3-2	1	—	10.7	8.8	8
2	U-TV1XC	1	ø2	10.7	8.8	8
3	U-TV0.63XC	0.63	—	17	14	12.7
4	U-TV0.5XC-3	0.5	—	21.4	17.6	16
5	U-TV0.35XC-2	0.35	—	—	—	22
6	U-TV0.25XC	0.25	—	—	—	—

For information on digital cameras, please visit our website at <http://www.olympus-ims.com/en/microscope/dc/>



Eyepieces

Eyepiece for viewing directly into the microscope. Select based on desired field of view.

	■: Possible	FN (mm)	Diopter adjustment mechanism	Built-in cross reticle
1	WHN10X	22		
2	WHN10X-H	22	■	
3	CROSS WHN10X	22	■	■
4	SWH10X-H	26.5	■	
5	CROSS SWH10X	26.5	■	■



Optical Filters

Optics filters convert sample exposure light to various types of illumination. Select the appropriate filter for observation requirements.

BF, DF, FL

1, 2, 3	U-25ND50, 25, 6	Neutral density filter, transmittance 50%, 25%, 6%
4	U-25LBD	Daylight color filter
5	U-25LBA	Halogen color filter
6	U-25IF550	Green filter
7	U-25L42	UV-cut filter
8	U-25Y48	Yellow filter
9	U-25FR	Frost filter (required for the BX3M-URAS-S)

POL, DIC

10	U-AN-2	Polarization direction is fixed
11	U-AN360-3	Polarization direction is rotatable
12	U-AN360P-2	High-quality polarization direction is rotatable
13	U-PO3	Polarization direction is fixed
14	U-POTP3	Polarization direction is fixed, for use with U-DICRH
15	45-IF546	Green ø45 mm filter for POL

Other

22	U-25	Empty filter, for use with user's ø25 mm filters
23	U-FC	Transmitted filter cassette; used by combining ø45 mm filters



IR

16	U-AN360IR	IR polarization direction is rotatable (reduces halation at IR observation when using combination with U-AN360IR and U-POIR)
17	U-POIR	IR polarization direction is fixed
18	U-BP1100IR	Band pass filter: 1100 nm
19	U-BP1200IR	Band pass filter: 1200 nm

Transmitted light

20	43IF550-W45	Green ø45 mm filter
21	U-POT	Polarizer filter

●AN and PO are not necessary when using BX3M-RLAS-S and U-FDICR

Condensers

Condensers collect and focus transmitted light. Use for transmitted light observation.

1	U-AC2	Abbe condenser (available for 5X objectives and above)
2	U-SC3	Swing-out condenser (available for 1.25X objectives and above)
3	U-LWCD	Long working distance condenser for glass plates (U-MSSPG, U-SPG64)
4	U-POC-2	Swing-out condenser for POL



Mirror Units

Mirror unit for BX3M-URAS-S. Select the unit for required observation.

1	U-FBF	For BF, detachable ND filter
2	U-FDF	For DF
3	U-FDICR	For POL, crossed nicol position is fixed
4	U-FBFL	For BF, built-in ND filter (it is necessary to use both BF* and FL)
5	U-FWUS	For Ultra Violet-FL: BP330-385 BA420 DM400
6	U-FWBS	For Blue-FL: BP460-490 BA520IF DM500
7	U-FWGS	For Green-FL: BP510-550 BA590 DM570
8	U-FF	Empty mirror unit

*For coaxial episcopic illumination only



Intermediate Tubes

Various types of accessories for multiple purposes. For use between tube and illuminator.

1	U-CA	Magnification changer (1X, 1.25X, 1.6X, 2X)
2	U-ECA	Magnification changer (1X, 2X)
3	U-EPA2	Eye point adjuster: +30 mm
4	U-DP	Dual port for U-DP1XC
5	U-DP1XC	C-mount TV camera adapter for U-DP
6	U-TRU	Trinocular intermediate unit



UIS2 Objectives

Objectives magnify the sample. Select the objective that matches the working distance, resolving power, and observation method for the application.

Objectives		Magnifications	NA	W.D. (mm)	Cover Glass Thickness*3 (mm)	Resolution*4 (µm)
MPLAPON	1	50X	0.95	0.35	0	0.35
	2	100X	0.95	0.35	0	0.35
MPLFLN	3	1.25X*5+6	0.04	3.5	0-0.17	8.39
	4	2.5X*6	0.08	10.7	0-0.17	4.19
	5	5X	0.15	20.0	0-0.17	2.24
	6	10X	0.30	11.0	0-0.17	1.12
	7	20X	0.45	3.1	0	0.75
	8	40X*2	0.75	0.63	0	0.45
	9	50X	0.80	1.0	0	0.42
SLMPLN	11	20X	0.25	25	0-0.17	1.34
	12	50X	0.35	18	0	0.96
	13	100X	0.6	7.6	0	0.56
LMPLFLN	14	5X	0.13	22.5	0-0.17	2.58
	15	10X	0.25	21.0	0-0.17	1.34
	16	20X	0.40	12.0	0	0.84
	17	50X	0.50	10.6	0	0.67
MPLN*5	18	100X	0.80	3.4	0	0.42
	19	5X	0.10	20.0	0-0.17	3.36
	20	10X	0.25	10.6	0-0.17	1.34
	21	20X	0.40	1.3	0	0.84
LCPLFLN-LCD	22	50X	0.75	0.38	0	0.45
	23	100X	0.90	0.21	0	0.37
	24	20X	0.45	8.3-7.4	0-1.2	0.75
MPLFLN-BD*7	25	50X	0.70	3.0-2.2	0-1.2	0.48
	26	100X	0.85	1.2-0.9	0-0.7	0.39
	27	5X	0.15	12.0	0-0.17	2.24
	28	10X	0.30	6.5	0-0.17	1.12
MPLFLN-BDP*7	29	20X	0.45	3.0	0	0.75
	30	50X	0.80	1.0	0	0.42
	31	100X	0.90	1.0	0	0.37
	32	150X	0.90	1.0	0	0.37
MPLFLN-BDP*7	33	5X	0.15	12.0	0-0.17	2.24
	34	10X	0.25	6.5	0-0.17	1.34
	35	20X	0.40	3.0	0	0.84
	36	50X	0.75	1.0	0	0.45
LMPLFLN-BD*7	37	100X	0.90	1.0	0	0.37
	38	5X	0.13	15.0	0-0.17	2.58
	39	10X	0.25	10.0	0-0.17	1.34
	40	20X	0.40	12.0	0	0.84
MPLN-BD*5+7+8	41	50X	0.50	10.6	0	0.67
	42	100X	0.80	3.3	0	0.42
	43	5X	0.10	12.0	0-0.17	3.36
	44	10X	0.25	6.5	0-0.17	1.34
MPLAPON	45	20X	0.40	1.3	0	0.84
	46	50X	0.75	0.38	0	0.45
	47	100X	0.90	0.21	0	0.37
MPLAPON		100XOil*1	1.4	0.1	0	0.24



*1 Specified oil: IMMOIL-F30CC

*2 The MPLFLN40X objective is not compatible with the differential interference contrast microscopy

*3 0: For viewing specimens without a cover glass

*4 Resolutions calculated with aperture iris diaphragm wide open

*5 Limited up to FN 22, no compliance with FN 26.5

*6 Analyzer and polarizer are recommended for usage with MPLFLN1.25X and 2.5X

*7 BD: Brightfield/Darkfield objectives

*8 Slight vignetting may occur in the periphery of the field when MPLN-BD series objectives are used with high-intensity light sources such as mercury and xenon for darkfield observation

Definition for Objective Lens Abbreviations

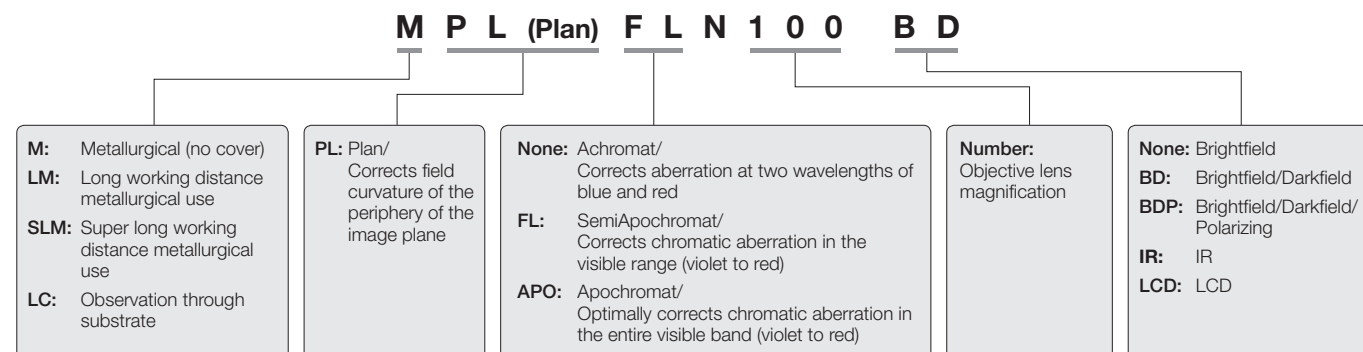

BX53M System Diagram (for Reflected and Reflected/Transmitted Light Combination)

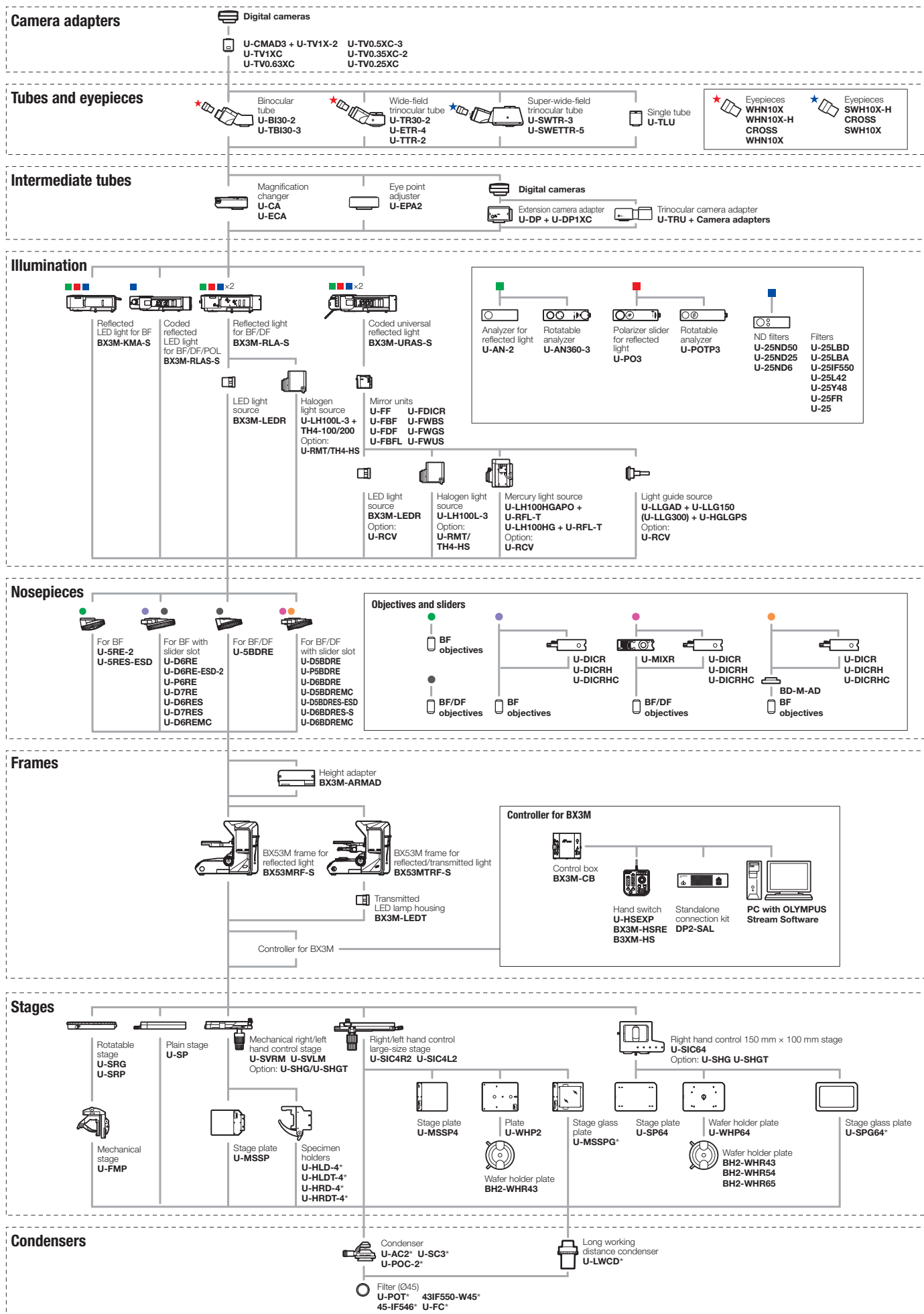

*For transmitted light combination only

Control box and cable connection diagram

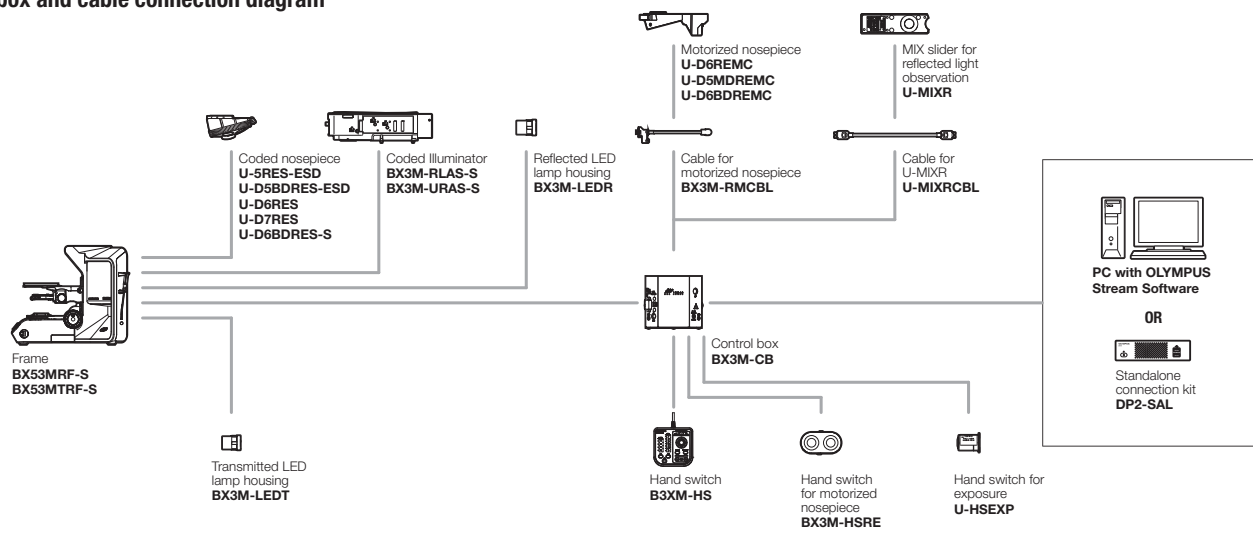

Stand-alone light manager configuration

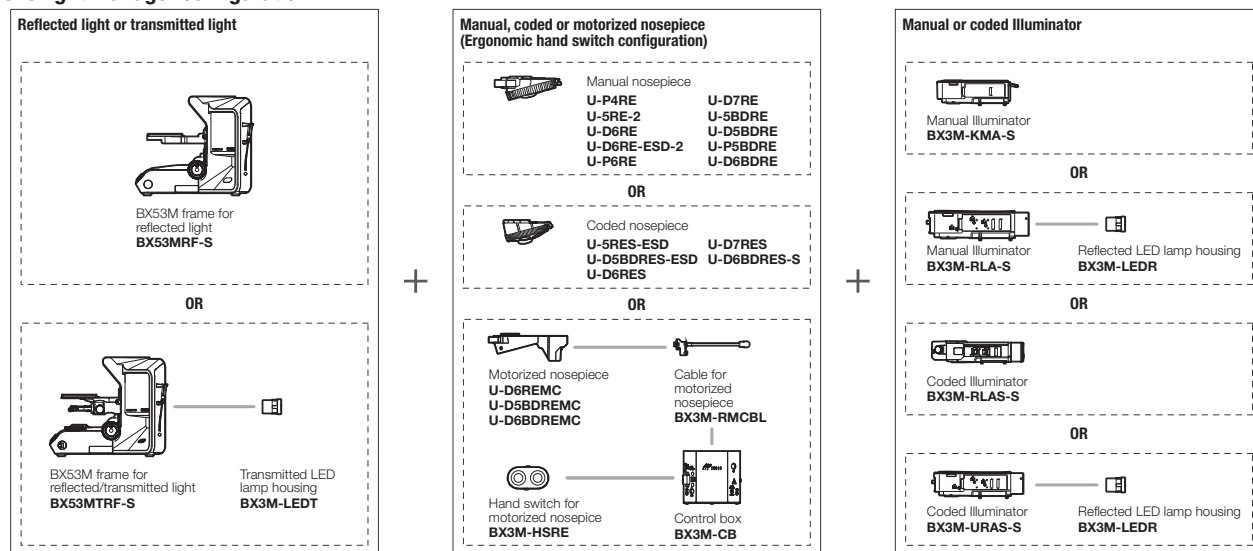

MIX observation configuration

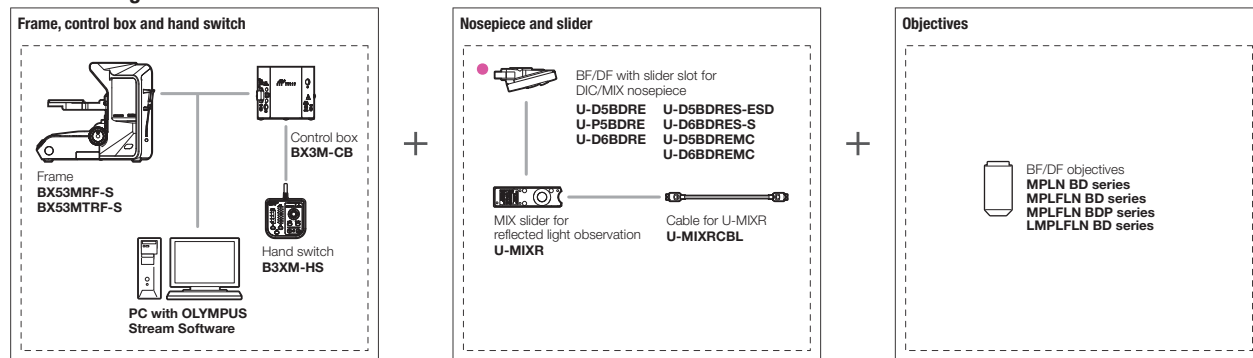

BXFM System Diagram

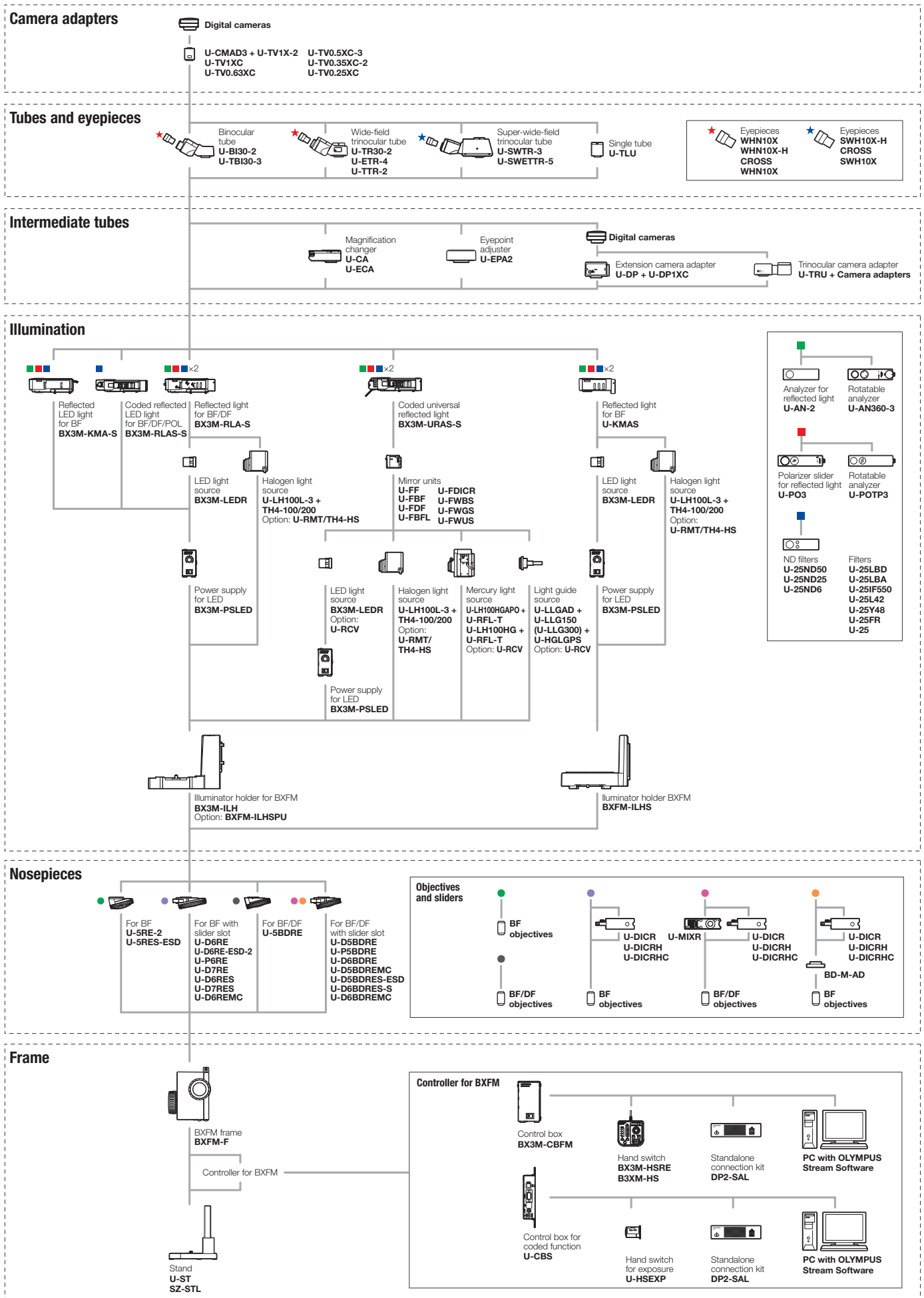

Control box and cable connection diagram

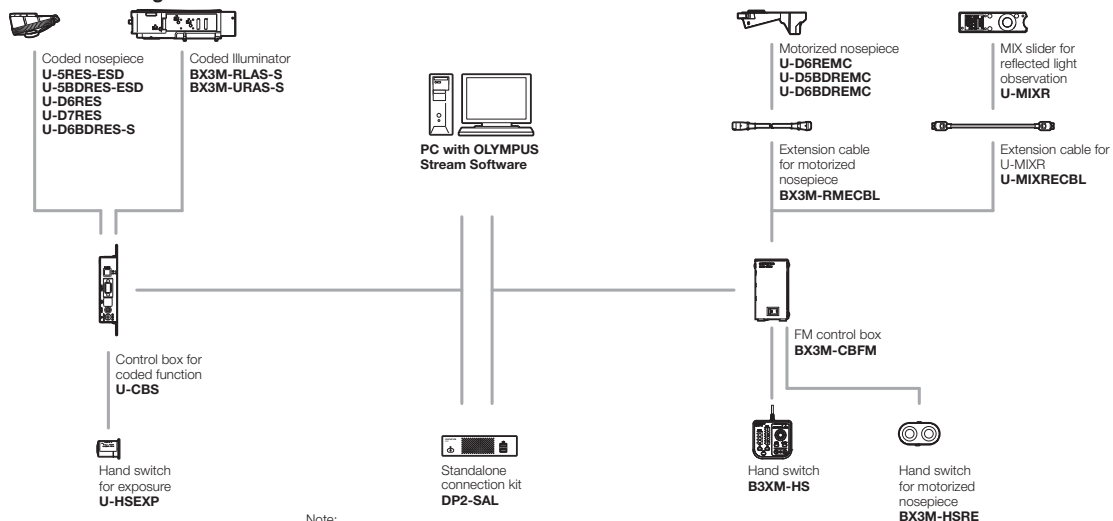

Note:
DP2-SAL is available only with either the coded system or the motorized system, but not with both.

MIX observation configuration

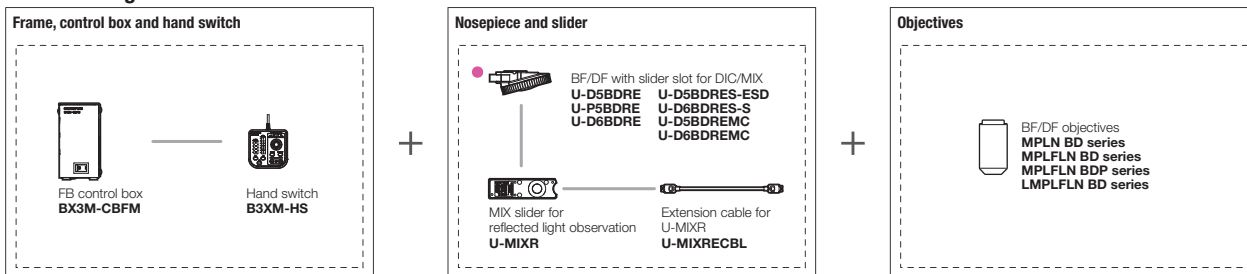

Motorized nosepiece configuration

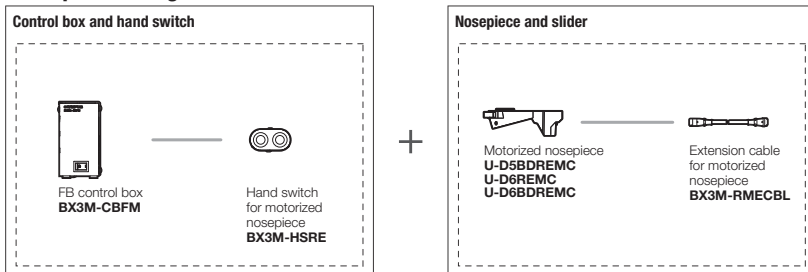

BX53M System Diagram (for IR Observation)

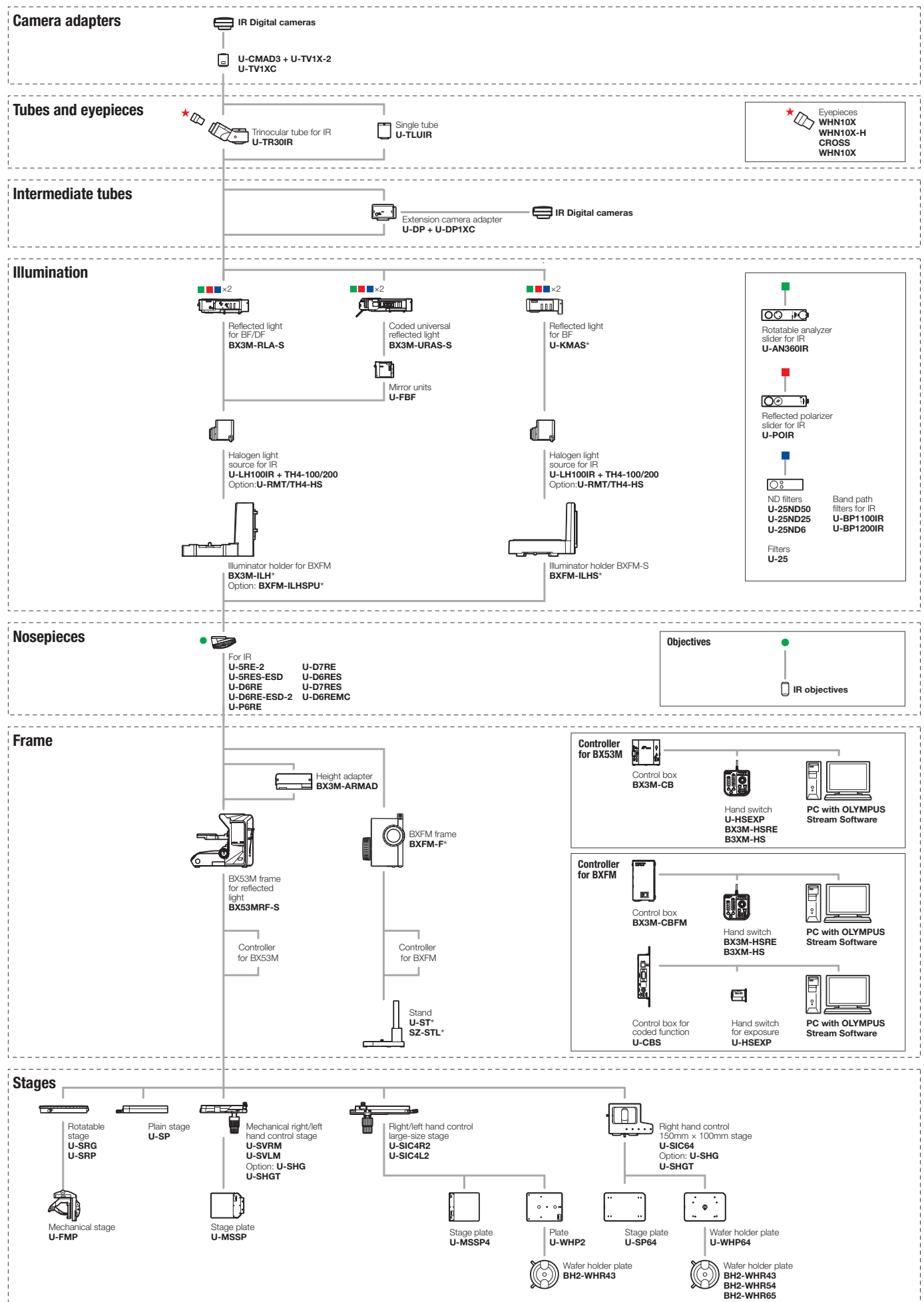

*For BXFM system only

BX53M System Diagram (for Polarized Observation)

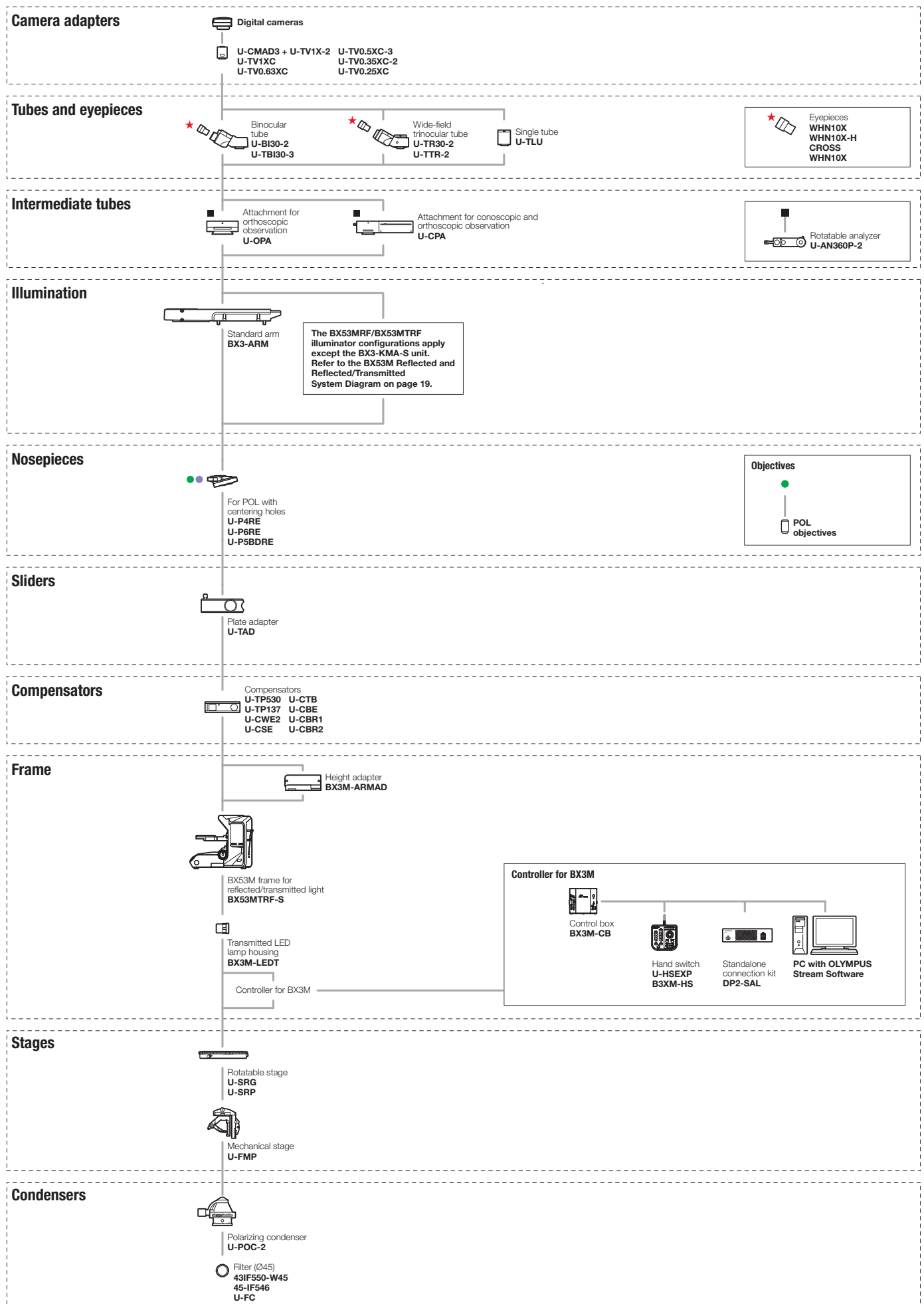

Specifications

BX53M Specifications (for Reflected and Reflected/Transmitted Light Combination)

		BX53MTRF-S	BX53MRF-S	BXFM
Optical system		UIS2 optical system (infinity-corrected)		
Microscope frame	Illumination	Reflected/transmitted	Reflected	
	Focus	Stroke: 25 mm Fine stroke per rotation: 100 µm Minimum graduation: 1 µm With upper limit stopper, torque adjustment for coarse handle		Stroke: 30 mm Fine stroke per rotation: 200 µm Minimum graduation: 2 µm With torque adjustment for coarse handle
	Max. specimen height	35 mm (w/o spacer) 75 mm (with BX3M-ARMAD)	65 mm (w/o spacer) 105 mm (with BX3M-ARMAD)	Depends on the mounting configuration
Observation tube	Wide-field FN 22	Inverted: binocular, trinocular, tilting binocular Erect: trinocular, tilting binocular		
	Super-wide-field FN 26.5	Inverted: trinocular Erect: trinocular, tilting trinocular		
Reflected light illumination	Traditional observation technique	BX3M-RLAS-S Coded, white LED, BF/DF/DIC/POL/MIX FS, AS (with centering mechanism), BF/DF interlocking BX3M-KMA-S White LED, BF/DIC/POL/MIX FS, AS (with centering mechanism), BF/DF interlocking BX3M-RLA-S 100W/50W halogen lamp, white LED, BF/DF/DIC/POL/MIX/ FS, AS (with centering mechanism), BF/DF interlocking, ND filter		U-KMAS White LED, 100W halogen Fiber illumination, BF/DIC/POL/MIX
	Fluorescence	BX3M-URAS-S Coded, 100W mercury lamp, 4 position mirror unit turret, (standard: WB, WG, WU+BF etc) With FS, AS (with centering mechanism), with shutter mechanism		
Transmitted light		White LED Abbe/long working distance condensers	-	
Revolving nosepiece	For BF	Sextuple, centering sextuple, septuple, coded quintuple (optional motorized revolving nosepieces)		
	For BF/DF	Sextuple, quintuple, centering quintuple, coded quintuple (optional motorized revolving nosepieces)		
Stage (X × Y)		Coaxial left (right) handle stage: 76 mm × 52 mm, with torque adjustment Large-size coaxial left (right) handle stage: 100 mm × 105 mm, with locking mechanism in Y-axis Large-size coaxial right handle stage: 50 mm × 100 mm, with torque adjustment and locking mechanism in Y-axis		-
Weight		Approx. 18.3 kg (Microscope frame 7.6 kg)	Approx. 15.8 kg (Microscope frame 7.4 kg)	Approx. 11.1 kg (Microscope frame 1.9 kg)

BX53M Specifications (for IR Observation)

		BX53MRF-S	BXFM
IR Observation tube	Wide field FN 22	Inverted: trinocular	
Reflected light illumination	IR observation	BX3M-RLA-S 100W/50W halogen lamp for IR, BF/IR, AS (with centering mechanism), with band pass filter (1100 nm, 1200 nm) BX3M-URAS-S 100W/50W halogen lamp for IR, BF/IR, AS (with centering mechanism), with band pass filter (1100 nm, 1200 nm), with shutter mechanism	
		-	U-KMAS 100W/50W halogen for IR, BF/IR
Revolving nosepiece	For BF	Sextuple, centering sextuple, septuple, coded quintuple (optional motorized revolving nosepieces)	
Stage (X × Y)		Coaxial left (right) handle stage: 76 mm × 52 mm, with torque adjustment Large-size coaxial left (right) handle stage: 100 mm × 105 mm, with locking mechanism in Y-axis Large-size coaxial right handle stage: 150 mm × 100 mm, with torque adjustment and locking mechanism in Y-axis	
Weight		Approx. 18.9 kg (Microscope frame 7.4 kg)	Approx. 11.6 kg (Microscope frame 1.9 kg)

BX53M Specifications (for Polarized Observation)

		BX53MTRF-S
Polarized light intermediate attachment (U-CPA or U-OPA)	Wide field FN 22	Inverted: binocular, trinocular, tilting binocular Erect: trinocular, tilting binocular
	Bertrand lens	Focusable (for U-CPA only)
	Bertrand field stop	ø3.4 mm diameter (fixed) (for U-CPA only)
	Engage or disengage Bertrand lens changeover between orthoscopic and conoscopic observation	Position of slider ● in Position of slider ○ out (for U-CPA only)
	Analyzer Slot	Rotatable analyzer with slot (U-AN360P-2)
Analyzer (U-AN360P-2)		360° dial-rotatable Rotatable minimum angle 0.1°
Revolving centerable nosepiece (U-P4RE)		Quadruple, centerable attachable components: 1/4 wavelength retardation plate (U-TAD), tint plate (U-TP530) and various compensators can be attached using plate adapter (U-TAD)
Stage (U-SRP)		Polarizing rotatable stage with 3-point centering function 360° rotatable, lockable in any position, 360° graduated in 1° increments (minimum retardation resolution 6', using vernier scale) 45° click stop function Mechanical stage (U-FMP) can be attached
Condenser (U-POC-2)		Achromat strain-free condenser (U-POC-2), 360° rotatable polarizer with swing-out achromatic top-lens Click stop at position "0°" is adjustable NA 0.9 (top-lens in) NA 0.18 (top-lens out) Aperture iris diaphragm: adjustable from 2 mm to 21 mm diameters
Weight		Approx. 16.2 kg (Microscope frame 7.6 kg)

BX53M/BXFM ESD Units

Items	Microscope: frame: BX53MRF-S, BX53MTRF-S Illuminator: BX3M-KMA-S, BX3M-RLA-S, BX3M-URAS-S, BX3M-RLAS-S Nosepiece: U-D6BDRES-S, U-D6RE-ESD, U-D5BDREMC-ESD, U-5RES-ESD Stage: U-SIC4R2, U-SIC4L2, U-MSSP4
-------	---

Dimensions

BX53M (for Reflected Combination)

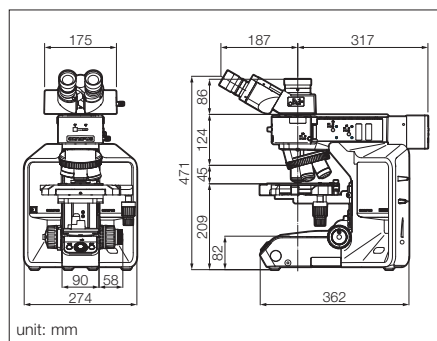

BX53M (for Reflected/Transmitted Light Combination)

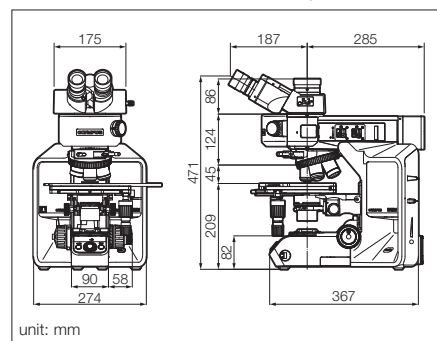

BXFM System

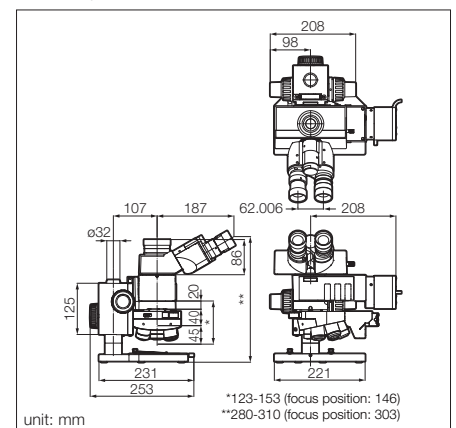

BX53M (for IR Observation)

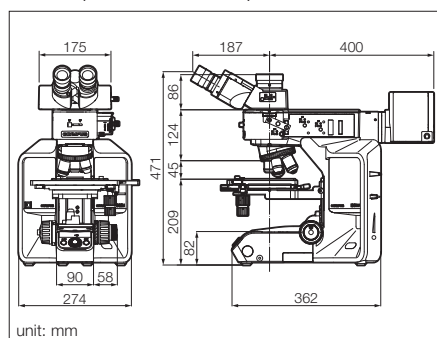

BX53M (for Polarized Observation)

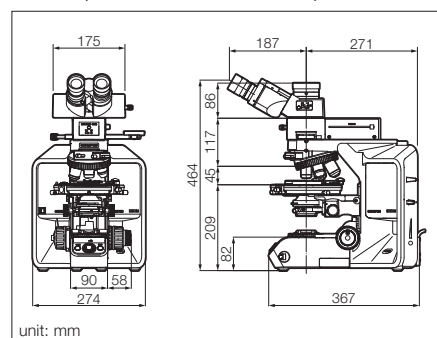

OLYMPUS offers an extensive product line for materials science and industrial microscopy. Learn more about the DSX series Digital Microscope and LEXT 3D Measuring Laser Microscope on our website, www.olympus-ims.com



LEXT 3D Measuring Laser Microscope

With the Olympus LEXT laser scanning microscope, non-contact 3D observations and measurements of surface features at 10-nanometer resolutions are easy to produce.



DSX Digital Microscope

The DSX's advanced digital technology delivers superior image quality with superb operating simplicity, making it perfect for users of any experience level. The DSX's intelligent interface is as simple as using a smartphone or tablet and backed by guaranteed accuracy and repeatability for 2D and 3D measurements.

www.olympus-ims.com

- OLYMPUS CORPORATION is ISO14001 certified.
 - OLYMPUS CORPORATION is ISO9001 certified.
 - This product is designed for use in industrial environments for the EMC performance. Using it in a residential environment may affect other equipment in the environment.
 - All company and product names are registered trademarks and/or trademarks of their respective owners.
 - Images on the PC monitors are simulated.
 - Specifications and appearances are subject to change without any notice or obligation on the part of the manufacturer.
 - Illumination devices for microscope have suggested lifetimes. Periodic inspections are required.
- Please visit our web site for details.



元利儀器股份有限公司
YUAN LI INSTRUMENT CO., LTD.

台北市內湖區陽光街365巷39號6樓
6F, 39, Lane365, Yang-Guang St., Taipei, Taiwan, R.O.C.
TEL: 886(2)8751-2222 FAX: 886(2)8751-5356