

**OLYMPUS**<sup>®</sup>

Your Vision, Our Future

Stereomicroscope

**SZX7/SZ61/SZ51**



**For Industrial Use**



# Comfort for your eyes — precision for your work

The human eye is a wonderful instrument, catching images of every moment of our lives.

At the same time it is extremely sensitive, and can become exhausted if it is not treated with care.

OLYMPUS has therefore made every possible effort to develop new optical systems that allow the human eye to feel comfortable and relaxed while working with stereo microscopes.

This not only protects the eyes but also leads to much more precise and consistent results in daily work.

All three models — the SZX7 with its advanced Galilean optical system, the full-featured SZ61 and the versatile SZ51 — provide 3D images with true color, high resolution and no distortion.

Welcome to the comfort zone.



**SZ51**

**SZ61**

## CONTENTS

Introduction — "The Comfort Zone" .....	1 - 12
• SZX7 Optical Performance	
• SZ61/SZ51 Optical Performance	
• Ergonomic Design	
• Illumination System	
• Digital Imaging & Recording System	
• Mounting System & Accessories	
Specifications .....	13 - 14
SZX7 System diagram .....	15 - 16
SZ61/SZ51 System diagram .....	17 - 18
Dimensions .....	Back Cover



**SZX7**



**SZ61TR**

*SZX7: Galilean optical system using parallel light paths for outstanding performance and easy expandability.*

*SZ61: Top-of-the-line optical performance, with zoom ratio of 6.7:1.  
Model variations: SZ61TR (with trinocular tube),  
SZ61-60 (with 60 degree observation tube inclination).*

*SZ51: Versatile, cost-efficient, ideal in all line inspection applications.*

## Optical excellence and system expandability — SZX7 with Galilean optics

“Providing the optimal image for any specimen” by the adoption of the Galilean optical system and the DF (Distortion Free) objective lens series with high N.A. (Numerical Aperture).

### **7:1 wide zoom ratio of the class**

With a magnification range of 8x-56x (using 1x objective lens/10x eyepiece), the SZX7 offers a maximum zoom ratio of 7:1. This useful zoom ratio allows most given specimen to be observed at the appropriate magnifications.

### **Excellent resolving power in this class**

Superior quality objective lenses deliver accurate, high resolution observation images which show every specimen in minute detail.

### **A range of objective lenses to suit every specimen and every application**

#### • Superior image flatness:

The DFPlan objective lens series accurately reproduces the original shape of the specimen.

#### • A long working distance (W.D.) is secured in this class:

The objective lenses range from the SZX-ACH1x (90mm W.D.) to the DFPL0.5x (198mm W.D.). As a result, even specimen surfaces which are difficult to access can be observed easily.

#### • Ideal for high magnification:

Superior quality image is ensured up to 336x, by combining a 2x objective lens with 30x eyepieces. Also available is an excellent apochromatic objective lens DFPLAPO1.25x, which reaches the higher zoom range of 1x through 7x.



*Galilean optics feature two (right/left) independent and parallel zoom optical paths to produce the focal point with one objective lens. The system enables high optical performance as well as functional modularity.*



**“ComfortView” eyepieces for greater comfort and faster work**

Quick, comfortable observation and documentation are ensured by this completely new eyepiece design featuring Pupil Aberration Control and Appropriate Positioning in the eye point.

**Accurate color reproduction**

The careful selection of lens surface coating and glass materials in the entire optical system make it possible to observe and document specimens in their original, authentic colors.

**Sharp, clear, high-contrast images**

The low, suppressed field curvature ensures accurate reproduction of original specimen shapes.

**A wide variety of observation tubes and intermediate tubes enable operators to obtain precisely the right image**

Various different types of tubes are available, and can be freely combined to create the ideal system for any specified purpose.

**SZX7 tubes:**

- Aperture diaphragm unit / SZX-AS
- Beam splitter / SZX2-LBS
- Eyepoint adjuster / SZX-EPA
- Filter adapter / SZX-FAD
- Macro tube / SZX-DA
- Photo adapter / SZX-PHA
- Side by side discussion tube / SZX-SDO2
- Coaxial reflected light illuminator / SZX2-ILLC10



Aperture diaphragm unit / SZX-AS



① 45 degree binocular head / SZX-BI45 ② Tilting trinocular head / SZX2-TTR  
③ 30 degree trinocular head / SZX-TR30

## Precise, functional and compact — SZ61/SZ51

"A practical range of functions for observation and documentation in a compact stereo microscope body"  
The SZ61/SZ51, incorporating the Greenough optical system.

### **6.7:1 wide zoom ratio**

The SZ61's wide magnification range extends from 6.7 through 45x (using 10x eyepiece), with the zoom ratio of 6.7:1. This derives from the newly developed optical system and allows quick, comfortable observations at the most appropriate magnification. The SZ51 provides a magnification range from 8x through 40x (using 10x eyepiece), with the zoom ratio of 5:1.

### **Outstanding depth of focus and flatness**

The 10-degree angle convergence of the image forming path in the Greenough optical system secures excellent image flatness with deep depth of focus.

### **"ComfortView" eyepieces for greater comfort and faster work**

Quick, comfortable observation and documentation are ensured by this completely new eyepiece design featuring Pupil Aberration Control and Appropriate Positioning in the eye point.

### **Accurate color reproduction**

The careful selection of lens surface coating and glass materials in the entire optical system make it possible to observe and document the specimen in their original, authentic colors.

### **Sharp, clear, high-contrast images**

The low, suppressed field curvature ensures accurate reproduction of original specimen shapes.



*The Greenough optical system has two zoom optical paths inclined at an inward angle. This enables a more compact microscope design while maintaining high performance.*



### **Five zoom body variations with high performance**

The SZ61 and SZ51 zoom bodies provide two different magnification ranges. They are available with an ergonomically designed 45-degree inclination tube for the use on the standard stands. For special applications where the zoom body has to be tilted for use with other equipment or mounting on a universal stand, models with 60-degree inclination tube (SZ61-60/SZ51-60) are available. For documentation purposes, OLYMPUS also offers the SZ61TR, which incorporates a trinocular tube for easy attachment of digital and video cameras.

### **Wide choice of auxiliary objective lenses**

A wide choice of auxiliary objective lenses enables observations at magnifications from 2x to 270x and W.D. up to 350mm to comply with every application purpose.



**SZ61/SZ51**



**SZ61-60/SZ51-60**



**SZ61TR**

## Work more comfortably...and more productively

The Olympus approach to ergonomic design seeks to achieve improvements that make work easier, more comfortable, and more productive, all at the same time. That means applying advanced technological methods to excellent operability, reducing factors that contribute to operator fatigue, and building in effective safety features like ESD design.

### **Ergonomic design based on 3D CAD analysis**

The microscope body and stand feature a design of precisely curved contours developed through careful 3D CAD analysis. Key ergonomic features include an all-round finish that's smooth to the touch and helps to reduce fatigue in long period observations.

### **Convenient front-access operation**

Improved ease of access to the most frequently used knobs and switches maximizes operator comfort and reduces back strain.

### **Tilting binocular tube for comfortable observations (SZX7)**

A comfortable position that minimizes the risk of back strain and muscle tension promotes productivity and quality in routine inspection tasks. The continuously adjustable tilting binocular tube helps the operator to quickly find the most comfortable eyepoint position.

### **Precise recall of specific magnification settings via integrated click-stop mechanism (SZX7) or zoom knob stopper (SZ61/SZ51)**

Many inspection tasks require the use of the same zoom magnification setting to ensure consistent and comparable

results. The integrated click-stop mechanism provides quick and easy access to this important function. The zoom knob stopper allows the user to choose magnification that can be quickly repeated, and the setting in use is clearly displayed on the front control panel.

### **New eyepiece reduces fatigue and excludes dust**

This eyepiece features a pupillary aberration control mechanism whereby the image remains visible even if the operator's eyes move. This has been found to lessen operator fatigue in long lasting observations. The unique eyepiece mounting design excludes dust particles and keep the eyepiece firmly in place ensuring clear images and ergonomically designed eyepiece position.

### **ESD safety design**

The increasing miniaturization and complexity of electronic devices raises the risk of damage by electric shock caused by electrostatic discharge. For this reason, OLYMPUS has taken special measures to design its stereo microscope bodies and main accessories to discharge static electricity from 1000V down to 100V in less than 0.2 seconds, protecting the equipment and preventing damage to samples.



LED Transmitted / Reflected Light Illumination Stand



Tilting trinocular / binocular head (SZX7)



Zoom handle





Click-stop mechanism (SZX7)



Zoom knob stopper (SZ61/SZ51)



Eyepiece lock



Ground wire connection (back side)

# OLYMPUS light solutions maximizes visibility in different tasks

OLYMPUS offers a range of light solutions perfectly tuned to the optical system of the zoom stereo microscope, to maximize the visibility of even minute characteristics.

## The new LED integrated reflected/transmitted illumination stand

The universal reflected/transmitted illumination stand brings together all the advantages of LED technology. It allows the simultaneous use of reflected and transmitted illumination, and can alter their respective intensities continuously and separately by means of convenient dials on the stand. The use of slim, high-brightness LED's successfully integrates transmitted illumination in a very slim base just 25mm thick that allows easy specimen access and manipulation. The complete microscope including LED integrated stand is extremely lightweight, compact and easy to carry.

## Universal reflected illumination systems

Fiber optic illumination systems offer the excellent illumination quality and flexibility. OLYMPUS offers a compact, cost effective 22W light source (SZ2-LGB) and a 100W light source (LG-PS2\*) for professional use. Homogeneous illumination can be achieved by a ring light. For special contrast effects on free form 3D shapes, OLYMPUS offers a choice of single and double self supporting spot illumination fiber guides and precisely adjustable flexible fiber guides.

\*An equivalent model may be offered in some areas.

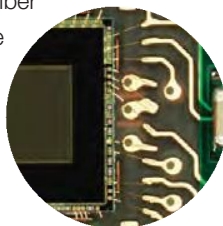

Homogeneous light

## Transmitted light illumination systems

For all transparent materials as well as for background illumination for the inspection of through holes, the OLYMPUS choice of illumination stands ranges from simple brightfield/simple oblique (SZX2-ILLK) up to brightfield/darkfield (SZX2-ILLD) and brightfield/oblique Koehler (SZX2-ILLB) illumination models. Also available is a brightfield/oblique illumination attachment (SZ2-ILA) that can accommodate various light sources including a 100W halogen lamp housing.

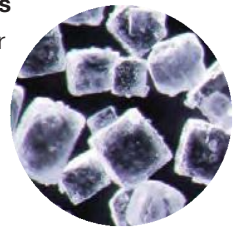

Darkfield light

## Special Illumination Techniques

### • Looking into holes

OLYMPUS offers effective coaxial illuminators for the SZX7 (SZX2-ILLC10) and the SZ61/SZ51 (SZ2-ILLC) which direct the light through the microscope's optical axis onto the specimen.

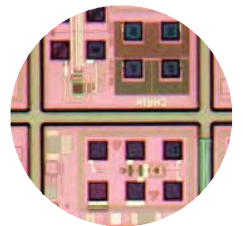

Coaxial light

### • Mirrored Surfaces

The illumination of highly reflective specimens needs special techniques in order to avoid disturbing light reflections. For spot and ring light illuminators as well as for coaxial

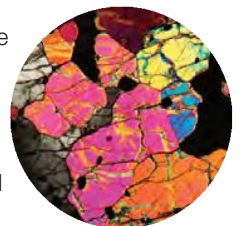

Polarized light



Flexible angle of LED light source



Homogeneous illuminations fiber optic systems



Intelligent LED ring illumination



White LED illumination unit



illuminators, OLYMPUS offers dedicated polarizing equipment which eliminates such light effects (LG-R66PL for ring light illumination).

**Making stress in transparent materials visible**

Also available are simple and advanced transmitted illumination stands with polarizing equipment (SZX2-AN, SZX-POL and SZ-POL2) for the efficient evaluation of tensions in transparent materials like plastic and glass. Their ease of use allows continuous, reliable production control of processes like injection molding.

*The transmitted/reflected integrated LED illumination stand's slim body and easy operation enables quick observations in a comfortable posture.*



Single illuminations fiber optic systems



Transmitted and coaxial illuminations with fiber optic systems



High power fiber optic illumination system

## Digital imaging



SZX7 in combination with DP73 digital camera system



SZX7 in combination with DP26 digital camera system



DP21 digital camera mounting on the SZ61

### **High Resolution Digital Camera DP73**

This outstanding 17.3-megapixel cooled digital camera with pixel-shift technologies attains superior resolving power, sensitivity and precise 14-bit (16384 steps) color fidelity. The DP73 is compatible with all the light microscopic observation methods and produces contrast balanced images using a unique dynamic range technology. ISO1600 sensitivity delivers clear display even for faint fluorescence signals. A high-definition 1600 x 1200-pixel image can be displayed live at a rate of 15 frames per second, without compression and a maximum 4800 x 3600-pixel image can be instantly saved.

### **Digital Camera DP26**

This high-resolution 5-megapixel color CCD camera provides excellent performance in brightfield observation for most applications. The DP26 incorporates progressive scanning that is free from color shift and offers high-speed IEEE1394b connectivity. It accommodates a wide range of applications with high color fidelity images.

### **High-speed , Compact Digital Camera DP21**

This 2-megapixel color CCD camera can be controlled from a space intuitively operated hand-switch. The DP21 has the power to display UXGA images comparable to high-definition at a smooth 15 frames per second. Seamless viewing is sustained even when changing focus or moving the inspection spot. The hand-switch incorporates the 12 most frequently used measurement functions for efficient inspection of industrial parts.

## Wide range of accessories to meet the needs of every application

### Easy mounting with other equipment (bonder and prober arms)

The SZX7, SZ61 and SZ51 are designed to be integrated into process equipment. OLYMPUS offers various bonder and prober arms for all common brands.



① B & L style bonder arm / SZ2-STB1 ② Bonder arm / SZ2-STB2 ③ Bonder arm / SZ2-STB3  
④ Prober arm / SZ2-STP ⑤ Arm for SZX stand / SZ2-ST5 ⑥ Adapter for B & L bonder arm / SZ-BLAD



### Ergonomic low positioned focus handle and more stage adapters

With the focusing unit SZ2-FO, focus adjustment can be done with the hands resting on the work surface. The action of focusing requires minimal force as the microscope zoom body does not need to be moved. This allows prolonged work on difficult samples without fatigue. There are also more stage adapters including the cup stage SZH-SC which gives the specimen a slant angle till 30 degrees from the level.



### Various universal stands

A variety of universal stands are available for the observation of large size specimens. No matter how big the samples are or how much they vary in size, OLYMPUS has the right choice of stands to suit any requirements.



SZX7+SZ2-STU2



SZ61+SZ2-STU3

## ■ SZX7 specifications

Item	Specifications			
<b>Zoom microscope body</b> SZX-ZB7	Zoom drive: Horizontal knob system Click stop for each zoom magnification: ON-OFF switching possible Zoom ratio values: 7:1 (0.8x to 5.6) Zoom magnification indication: 0.8, 1, 1.25, 1.6, 2, 2.5, 3.2, 4, 5, 5.6 Objective lens mouting: Screw mounting into thread Lead-free materials used			
Aperture iris diaphragm control: The AS unit (SZX-AS) is mountable				
<b>Observation tube</b> SZX-BI45 SZX-TBI SZX2-TTR SZX2-TR30	<b>SZX-BI45</b>	<b>SZX-TBI / SZX2-TTR</b>	<b>SZX2-TR30</b>	
	Binocular tube View inclination angle 45° Lead-free materials used	Tilting binocular (trinocular) tube View tilting angle 5° to 45°	Trinocular tube View inclination angle 30° Light path selection: 2 steps (Binocular 100%, Video 50%/Binocular 50%)	
Interpupillary distance adjustable range: 52 to 76 mm Eyepiece clamping knob provided				
<b>Stand</b> SZ2-ST SZ2-ILST	<b>SZ2-ST</b>		<b>SZ2-ILST</b>	
	Standard stand		LED reflected/transmitted illumination stand	
	Frame installation	Mounting diameter 76mm		
	Focusing adjustment	Knob rotation tension adjustment Focusing stroke 120mm		
	Stage plate	SZ2-SPBW (Black & white) SP-C (Glass clear transparent)	The dedicated glass plate in 100mm dia. included	
Light source	Fiber optic illumination system SZ2-LGB mountable (option) Transmitted light illumination attachment (SZ2-ILA) mountable (option)	Transmitted illumination: LED Reflected illumination: LED Average LED life span: 6000 hrs. Input rating: 100-120V/200-240V~0.15/0.1A, 50/60Hz		
<b>Objective lens</b>  *1 The SZ2-ET auxiliary sleeve is required when the SZ2-ST/SZ2-ILST is used.	<b>Model</b>		<b>Working distance</b>	
	DFPL0.5x-4*1 DFPL0.75x-4 DFPLA01x-4 SZX-ACH1x DFPLA01.25x SZX-ACH1.25x-2 DFPL1.5x-4 DFPL2x-4  All objective lenses: lead-free materials		171mm 116mm 81mm 90mm 60mm 68mm 45.5mm 33.5mm	
<b>Eyepieces</b>	"ComfortView" WHSZ series All eyepieces: lead-free materials			
<b>Weight</b>	Configuration 1	4,360g	5,400g	5,200g
	Configuration 2	5,160g	6,200g	6,000g

Configuration 1: SZX-ZB7 + DFPLA01x-4 + individual observation tube + WHSZ10x-H (2) + SZ2-ST

Configuration 2: SZX-ZB7 + DFPLA01x-4 + individual observation tube + WHSZ10x-H (2) + SZ2-ILST

## ■ SZ61/SZ51 specifications

Item	Specifications				
<b>Microscope body</b> SZ61 SZ61-60 SZ61TR SZ51 SZ51-60	<b>SZ61</b>	<b>SZ61-60</b>	<b>SZ61TR</b>	<b>SZ51</b>	<b>SZ51-60</b>
	Magnification	0.67x to 4.5x			0.8x to 4x
	Zoom ratio	6.7: 1			5: 1
	Working distance	110mm			
	Tube inclination angle	45°	60°	45°	60°
	Interpupillary distance adjustment	Left/right interlocked Adjustment range: 52 to 76 mm (using the WHSZ10X eyepieces)			
	Video camera adaptability	—		C-mount (0.5x built in)	—
	Zoom adjustment knob	Left/right single-shaft horizontal knob Interpupillary distance high/low magnification stopper incorporated.			
	Optical components	Lead-free materials used			
<b>Auxiliary objective lens</b>	Mounting by screwing into the thread at the bottom of frame (M48 thread x0.75)				
<b>Eyepiece</b>	"ComfortView" WHSZ series Lead-free materials used				
<b>Stand</b> SZ2-ST SZ2-ILST	<b>SZ2-ST</b>		<b>SZ2-ILST</b>		
	Standard stand		LED reflected/transmitted illumination stand		
	Frame installation	Mounting diameter: 76mm			
	Focusing adjustment	Focusing stroke: 120mm			
	Stage plate	SZ2-SPBW (Black & white for anti-ESD) SP-C (Clear glass plate)		The dedicated glass plate in 100mm dia. included	
Light source	Fiber optic illumination system SZ2-LGB mountable (option) Transmitted light illumination attachment (SZ2-ILA) mountable (option)		Transmitted illumination: LED Reflected illumination: LED Average LED life span: 6000 hrs. Input rating: 100-120V/200-240V ~0.15/0.1A, 50/60Hz		
<b>Weight</b>	Zoom body only	1,300g	1,500g	1,300g	
	Configuration 3	3,520g	3,720g	3,520g	

Configuration3: Zoom body + WHSZ10X-H(2) + SZ2-ST

## ■ "ComfortView" WHSZ eyepiece

	F.N.	Diopter adjustment	Reticle	Focal magnification
WHSZ10x	22	—	N.A.	—
WHSZ20x	12.5	—	N.A.	—
WHSZ10x-H	22	-8+5	Yes*2	—
WHSZ15x-H	16	-8+5	Yes*2	—
WHSZ20x-H	12.5	-8+5	Yes*2	1.3x
WHSZ30x-H	7	-8+5	Yes*2	2x

\*2Applicable reticle size: 24mm diameter, t1.5

## ■ Auxiliary objective lens for SZ61/SZ51

	Working distance (mm)
110ALK0.3x	250-350
110ALK0.4x	180-250
110AL0.5x	200
110AL0.62x	160
110AL0.75x	130
110AL1.5x	61
110AL2x	38

## ■ SZX7 optical performance

Eyepiece	WHSZ10x-H WHSZ10x		WHSZ15x-H		WHSZ20x-H WHSZ20x		WHSZ30x-H	
	F.N. 22		F.N. 16		F.N. 12.5		F.N. 7	
Objective lens	Total magnification	Field of view (mm)	Total magnification	Field of view (mm)	Total magnification	Field of view (mm)	Total magnification	Field of view (mm)
0.5x	4x-28x	55-7.8	6x-42x	40.0-5.7	8x-56x	31.3-4.5	12x-84x	17.5-2.5
0.75x	6x-42x	36.7-5.2	9x-63x	26.7-3.8	12x-84x	20.8-3.0	18x-126x	11.7-1.7
1x	8x-56x	27.5-3.9	12x-84x	20.0-2.9	16x-112x	15.6-2.2	24x-168x	8.8-1.3
1.25x	10x-70x	22-3.1	15x-105x	16.0-2.3	20x-140x	12.5-1.8	30x-210x	7.0-1.0
1.5x	12x-84x	18.3-2.6	18x-126x	13.3-1.9	24x-168x	10.4-1.5	36x-252x	5.8-0.83
2x	16x-112x	13.8-1.9	24x-168x	10.0-1.4	32x-224x	7.8-1.1	48x-336x	4.4-0.63

## ■ SZ61/SZ51 optical performance

Microscope Body	Zoom magnification	WHSZ10x-H WHSZ10x		WHSZ15x-H		WHSZ20x-H WHSZ20x		WHSZ30x-H	
		F.N. 22		F.N. 16		F.N. 12.5		F.N. 7	
		Total magnification	Field of view (mm)	Total magnification	Field of view (mm)	Total magnification	Field of view (mm)	Total magnification	Field of view (mm)
SZ61	0.67x	6.7	32.8	10.1	23.9	13.4	18.7	20.1	10.4
	1x	10	22	15	16	20	12.5	30	7.0
	2x	20	11	30	8	40	6.3	60	3.5
	3x	30	7.3	45	5.3	60	4.2	90	2.3
SZ51	4.5x	45	4.9	67.5	3.6	90	2.8	135	1.6
	0.8x	8	27.5	12	20	16	15.6	24	8.8
	1x	10	22	15	16	20	12.5	30	7.0
	2x	20	11	30	8.0	40	6.3	60	3.5
	3x	30	7.3	45	5.3	60	4.2	90	2.3
	4x	40	5.5	60	4.0	80	3.1	120	1.8

\* No auxiliary objective lens is attached

## ■ Fiber optic illumination system

Item		Specifications				
		SZ2-LGR	SZ2-LGDI	SZ2-LGDF	SZ2-LGSI	SZ2-LGSF
Type of fiber optic		Homogenous				
Type of illumination method		Double spot				
Tube	Type	Flexible	Interlocked (self supporting)	Flexible	Interlocked (self supporting)	Flexible
	Length	800mm	500mm	400mm	500mm	400mm
Fiber	Type	Multi-component LB56N equivalent, 50mm diameter				
	N.A.	0.56				
Bundle diameter	Input end	8mm	5.65mm	5.65mm	4mm	4mm
	Output end	70 x 0.22t mm	4mm	4mm	4mm	4mm
Minimum bending radius		30mm	65mm	30mm	65mm	30mm

## ■ Compact halogen light source SZ2-LGB

Item	Specifications
Dimensions and weight	90(W) x 153 (H) x 100(D) mm, 600g (AC adapter 200g)
Rated voltage	AC adapter: input/100-240V/50/60Hz, output/ 12VDC2A
Power consumption	22W
Bulb type	12V22W halogen bulb with mirror
Bulb model	12V22WHAL (Philips JCR12V22WA/3)
Average life span of bulb	2000 hours (STEP1, Min.), 580 hours (STEP2, Middle), 100 hours (STEP3, Max.)
Light intensity adjustment	Voltage adjustment (3 steps)
Applicable stand	SZ2-ST

## ■ LED ring illumination SZX2-ILR66

Item	Specifications
Features	4-part LED ring illumination 4-part independent ON/OFF available
Illumination	Operation modes : rotary, mirror ESD compatible, Clean class 1
Light source	17-step light intensity adjustable AC100-240V
Others	SZX-LGR66/SZ-LGR66 adapters are required for SZX7/SZ61 respectively

## ■ SZX7 system diagram

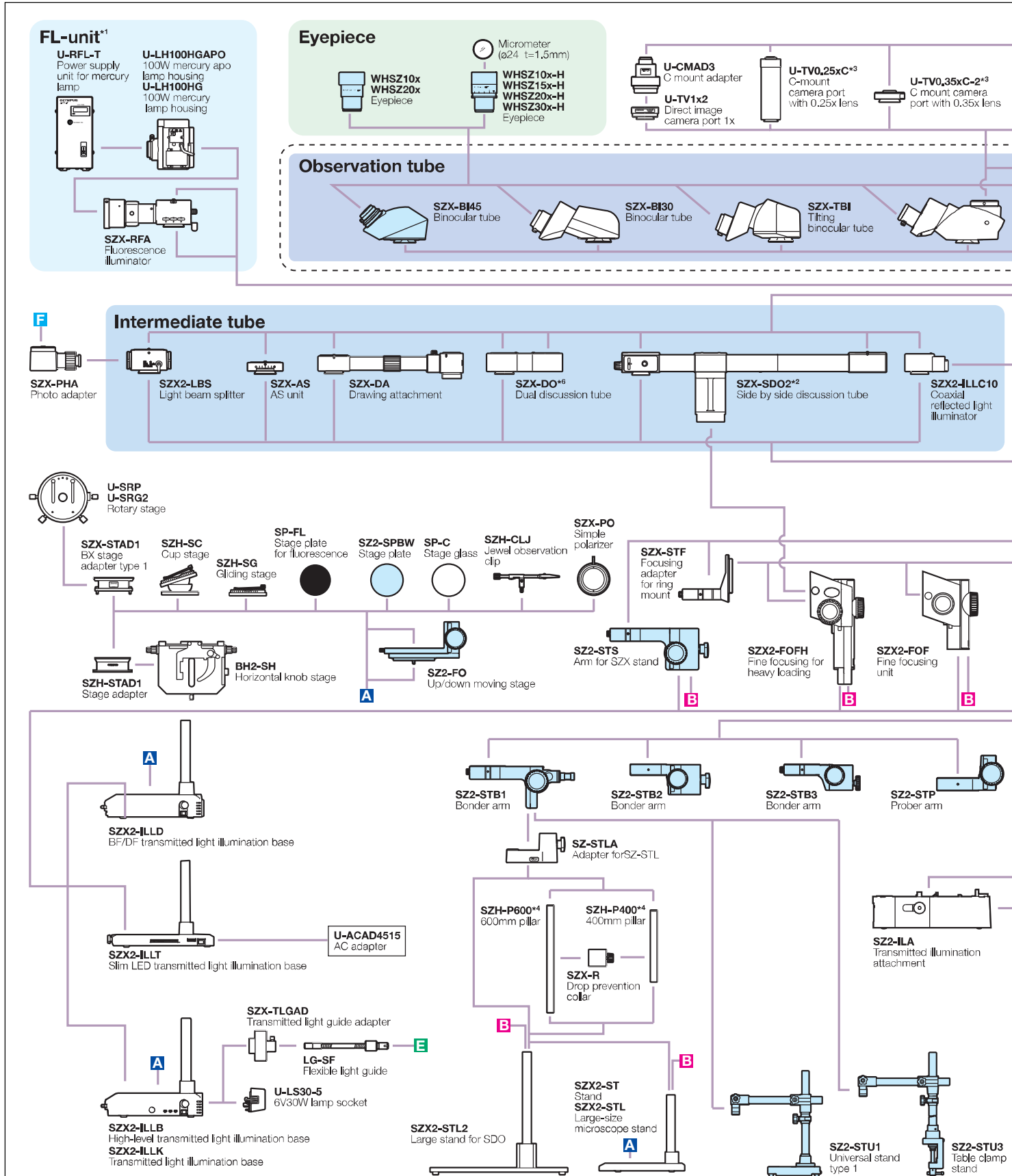

ESD compatible

<sup>1</sup> Focusing unit (SZX2-FOF, SZX-FOFH or SZX-FO) and SZX-STF are required when mounting fluorescent unit, <sup>2</sup> SZX2-FOFH and SZX2-STL2 are required when using SZX-SDO2, <sup>3</sup> Please contact your nearest <sup>4</sup> SZH-P400 and SZH-P600 can be attached to the transmitted light illuminators, <sup>5</sup> Equipped to SZX2-ILLC10, <sup>6</sup> Please contact your nearest Olympus dealer for applicable observation tube combination.



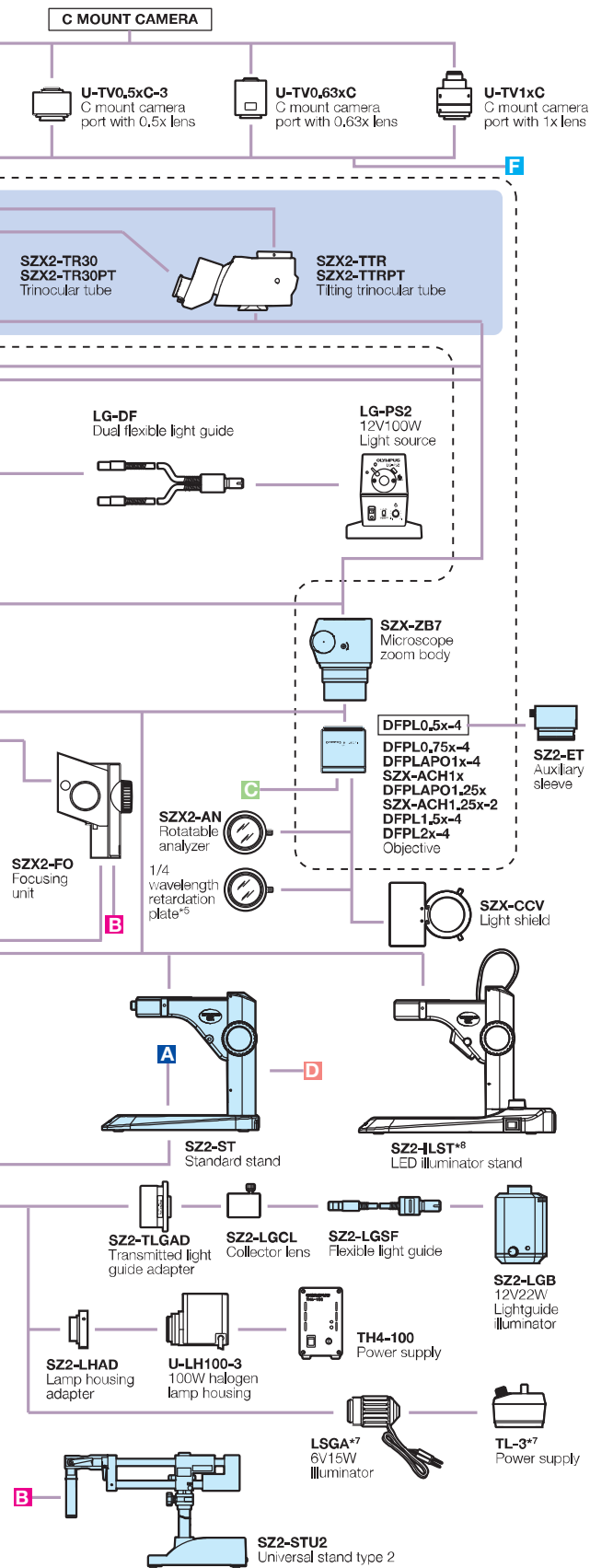

### Compact fiber optics system/SZ2-LGB

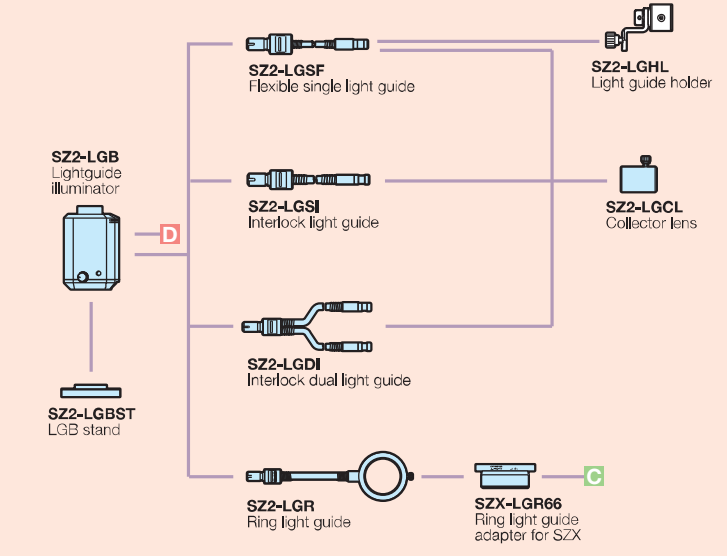

Consumables: JCR12V22WA/3

### High power fiber optics system/LG-PS2

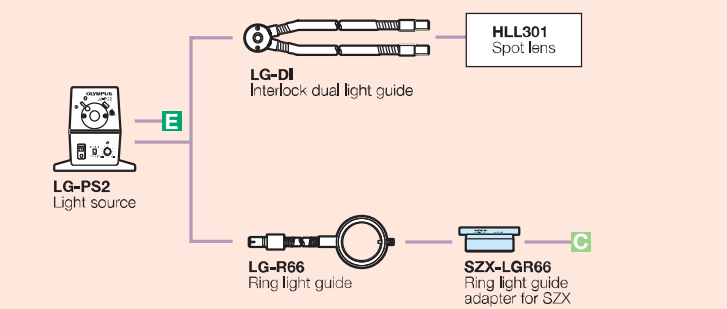

Consumables: JCR12V-100WB

### LED illumination system

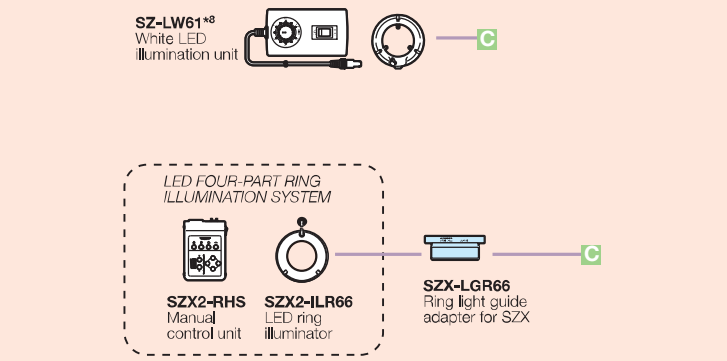

Olympus dealer for applicable cameras.  
 \*7 Not available in some areas. \*8 SZ-LW61 cannot be combined with SZ2-ILST.

■ SZ61/SZ51 system diagram

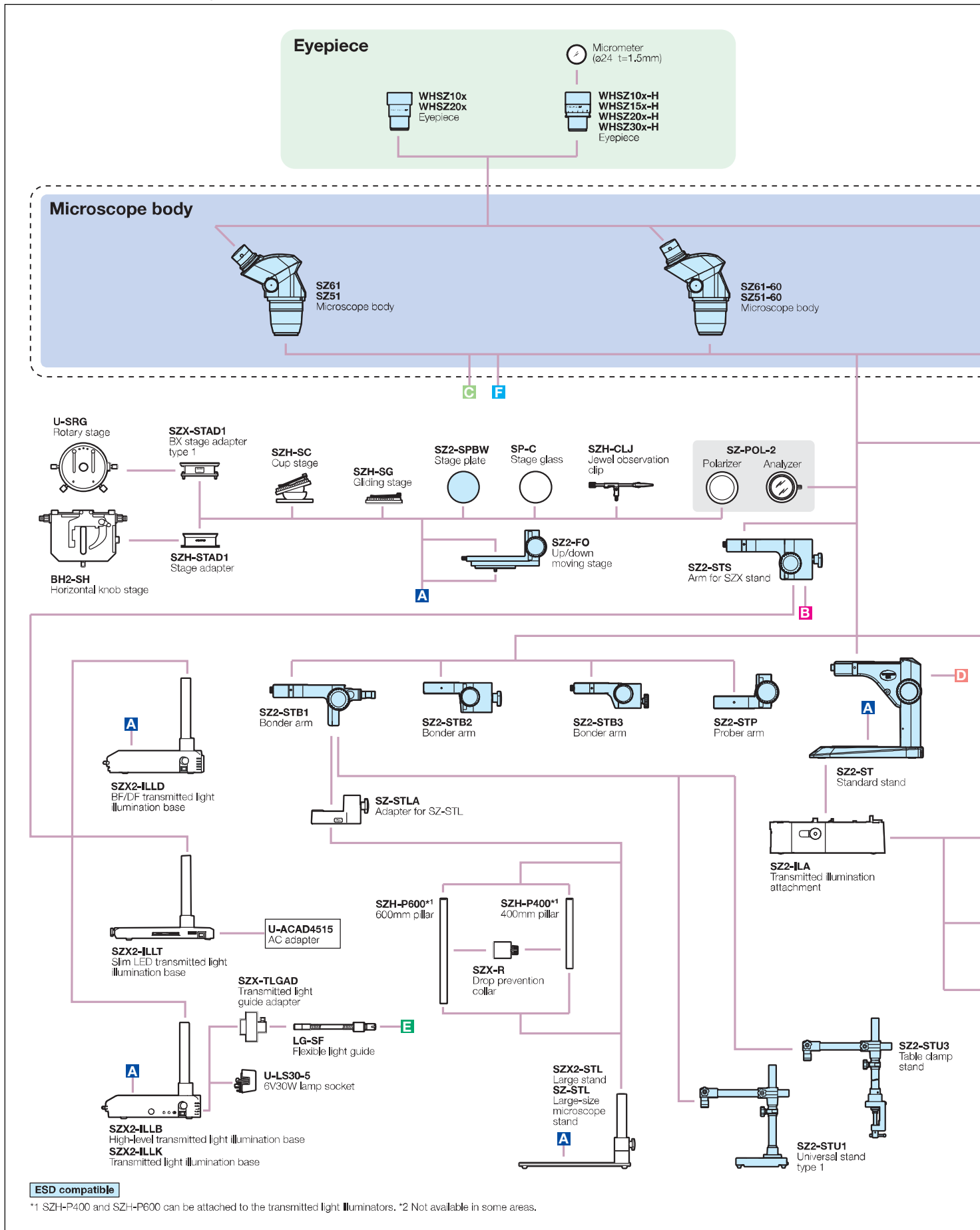

C MOUNT DIGITAL CAMERA,  
C MOUNT VIDEO CAMERA

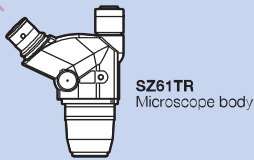

**SZ61TR**  
Microscope body

### Compact fiber optics system/SZ2-LGB

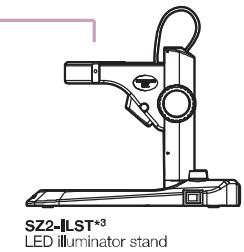
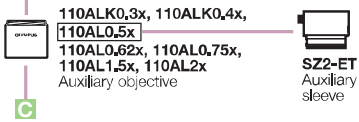
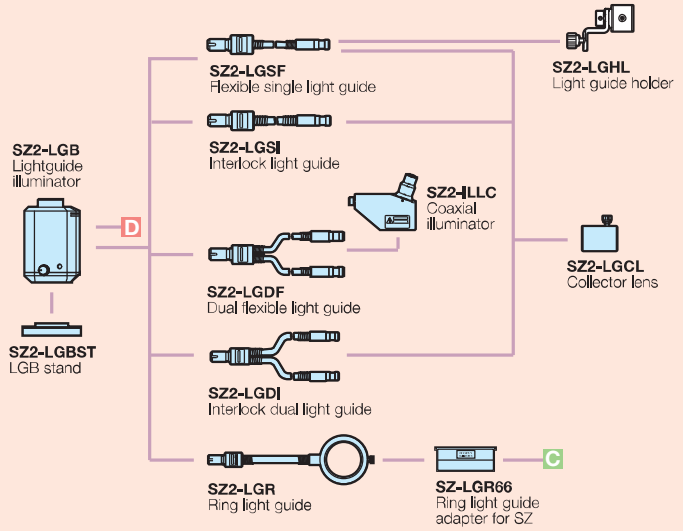

**SZ2-ILST\*3**  
LED illuminator stand

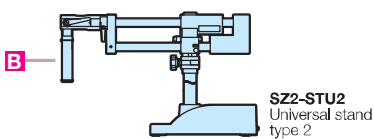
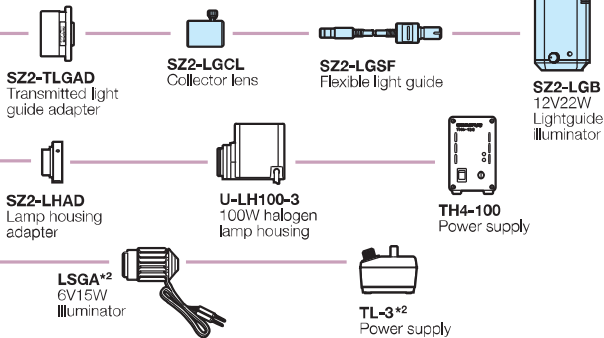

**SZ2-STU2**  
Universal stand  
type 2

### High power fiber optics system/LG-PS2

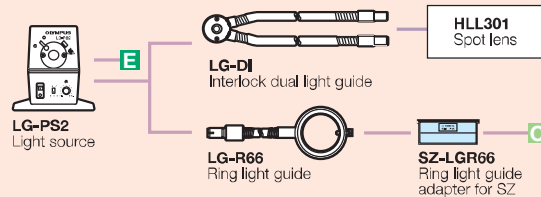

### Ring light illumination

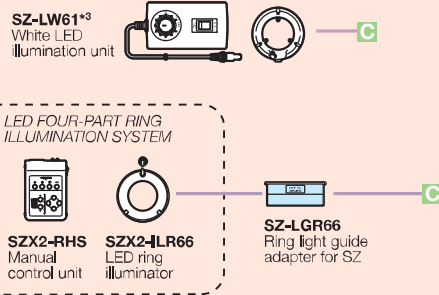

\*3 SZ-LW61 cannot be combined with SZ2-ILST.

### Reflected illumination/LSGA

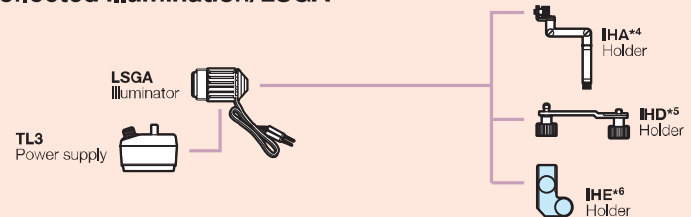

\*4 IHA is mountable to SZ2-ST, SZ2-STB1, SZ2-STB3, SZ2-ST5 and TL-3.

\*5 IHD is mountable to SZ2-STB1 and SZ2-ST5.

\*6 IHE is mountable to SZ2-ST.

■ SZX7 dimensions

SZX7

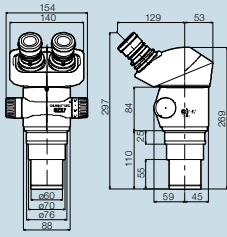

SZX7+SZ2-ST

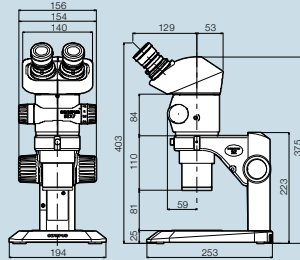

SZX7 (SZX2-TR30 configuration) +SZ2-ILST

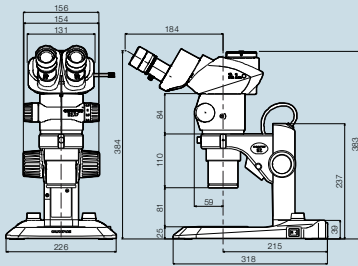

■ SZ61/SZ51 dimensions

SZ61/SZ51

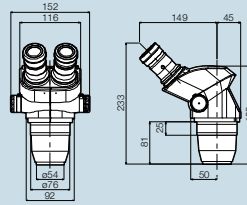

SZ61-60/SZ51-60

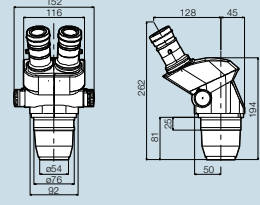

SZ61TR

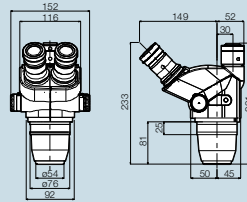

SZ61+SZ2-ST/  
SZ51+SZ2-ST

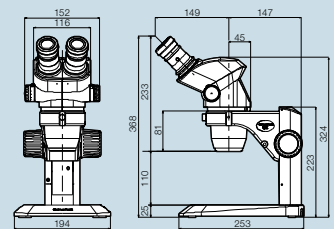

[www.olympus-ims.com](http://www.olympus-ims.com)

**OLYMPUS**<sup>®</sup>

For enquiries - contact  
[www.olympus-ims.com/contact-us](http://www.olympus-ims.com/contact-us)

**OLYMPUS CORPORATION**  
Shinjuku Monolith, 3-1, Nishi Shinjuku 2-chome, Shinjuku-ku, Tokyo, Japan  
**OLYMPUS EUROPA HOLDING GMBH**  
Wendenstrasse 14-18, 20097 Hamburg, Germany  
**OLYMPUS AMERICA INC.**  
3500 Corporate Parkway, Center Valley, Pennsylvania 18034-0610, U.S.A.  
**OLYMPUS (CHINA) CO., LTD.**  
11F, K, Wah Centre, 1010 Huaihai Rd(M), Xuhi District, Shanghai, P.R.C

- OLYMPUS CORPORATION is ISO9001/ISO14001 certified.
- Illumination devices for microscope have suggested lifetimes.  
Periodic inspections are required. Please visit our web site for details.
- All company and product names are registered trademarks and/or trademarks of their respective owners.
- Images on the PC monitors are simulated.
- Specifications and appearances are subject to change without any notice or obligation on the part of the manufacturer.

**OLYMPUS KOREA CO., LTD.**  
Olympus-Tower, 114-9 Samseong-Dong, Gangnam-Gu, Seoul, Korea  
**OLYMPUS SINGAPORE PTE LTD.**  
491B River Valley Road, #12-01/04 Valley Point Office Tower, Singapore  
**OLYMPUS AUSTRALIA PTY, LTD.**  
31 Gilby Road, Mt. Waverly, VIC 3149, Melbourne, Australia  
**OLYMPUS LATIN AMERICA, INC.**  
5301 Blue Lagoon Drive, Suite 290 Miami, FL 331269, U.S.A.